

SAMSUNG

INSTALL GUIDE

UHD TV

HG43BU800E HG50BU800E HG55BU800E
HG65BU800E HG75BU800E

Thank you for purchasing this Samsung product.

To receive more complete service, please register your product at www.samsung.com

Model _____ Serial No. _____

Before Reading This Install Guide

This TV B2B (Business to Business) model is designed for hotels or the other hospitality businesses, supports a variety of special functions, and lets you limit some user (guest) controls.

Figures and illustrations in this Install Guide are provided for reference only and may differ from the actual product appearance. Product design and specifications may change without notice.

Operational Modes

This TV has two modes: **Interactive** and **Standalone** mode.

- **Interactive** mode: In this mode, the TV communicates with and is fully or partially controlled by a connected Set Back Box (SBB) or Set Top Box (STB) provided by a hospitality System Integration (SI) vendor. When the TV is initially plugged in, it sends a command that attempts to identify the SBB or STB connected to it. If the TV identifies the SBB or STB and the SBB or STB identifies the TV, the TV gives full control to the SBB or STB.
- **Standalone** mode: In this mode, the TV works alone without an external SBB or the STB.

The TV has a **Hotel Option** menu that lets you easily set its various hospitality functions. Please see page 27.

The menu also lets you activate or de-activate some TV and hospitality functions so you can create your optimal hospitality configuration.

Still image warning







Avoid displaying still images (such as jpeg picture files) or still image elements (such as TV channel logos, panorama or 4:3 format images, stock or news bars or crawls) on the screen. Displaying still pictures continually can cause uneven screen wear, which will affect image quality. To reduce the chance that this effect will occur, please follow the recommendations below:

- Avoid displaying the same TV channel for long periods.
- Always try to display a full screen image.
- Reduce brightness and contrast to help prevent the occurrence of after-images.
- Use all TV features designed to reduce image retention and screen burn-in.

Warning! Important Safety Instructions

Please read the Safety Instructions before using your TV.

Refer to the table below for an explanation of symbols which may be on your Samsung product.

CAUTION			Class II product: This symbol indicates that a safety connection to electrical earth (ground) is not required. If this symbol is not present on a product with a main lead, the product MUST have a reliable connection to protective earth (ground).
RISK OF ELECTRIC SHOCK. DO NOT OPEN.			
CAUTION: TO REDUCE THE RISK OF ELECTRIC SHOCK, DO NOT REMOVE COVER (OR BACK). THERE ARE NO USER SERVICEABLE PARTS INSIDE. REFER ALL SERVICING TO QUALIFIED PERSONNEL.			AC voltage: Rated voltage marked with this symbol is AC voltage.
	This symbol indicates that high voltage is present inside. It is dangerous to make any kind of contact with any internal part of this product.		DC voltage: Rated voltage marked with this symbol is DC voltage.
	This symbol indicates that this product has included important literature concerning operation and maintenance.		Caution. Consult instructions for use: This symbol instructs the user to consult the install guide for further safety related information.

- The slots and openings in the cabinet and in the back or bottom are provided for necessary ventilation. To ensure reliable operation of this apparatus and to protect it from overheating, these slots and openings must never be blocked or covered.
 - Do not place this apparatus in a confined space, such as a bookcase or built-in cabinet, unless proper ventilation is provided.
 - Do not place this apparatus near or over a radiator or heat register, or where it is exposed to direct sunlight.
 - Do not place vessels (vases etc.) containing water on this apparatus, as this can result in a fire or electric shock.
- Do not expose this apparatus to rain or place it near water (near a bathtub, washbowl, kitchen sink, or laundry tub, in a wet basement, or near a swimming pool, etc.). If this apparatus accidentally gets wet, unplug it and contact an authorised dealer immediately.
- Please contact your local authorities for disposal or recycling information.
- Do not overload wall outlets, extension cords, or adaptors beyond their capacity, since this can result in fire or electric shock.
- Power-supply cords should be placed so that they are not likely to be walked on or pinched by items placed upon or against them. Pay particular attention to cords at the plug end, at wall outlets, and at the point where they exit from the appliance.
- To protect this apparatus from a lightning storm, or when left unattended and unused for long periods of time, unplug it from the wall outlet and disconnect the antenna or cable system. This will prevent damage to the set due to lightning and power line surges.

- Never insert anything metallic into the open parts of this apparatus. This may cause a danger of electric shock.
- To avoid electric shock, never touch the inside of this apparatus. Only a qualified technician should open this apparatus.
- Be sure to plug in the power cord until it is firmly seated. When unplugging the power cord from a wall outlet, always pull on the power cord's plug. Never unplug it by pulling on the power cord. Do not touch the power cord with wet hands.
- If this apparatus does not operate normally - in particular, if there are any unusual sounds or smells coming from it - unplug it immediately and contact an authorised dealer or Samsung service centre.
- Be sure to pull the power plug out of the outlet if the TV is to remain unused or if you are to leave the house for an extended period of time (especially when children, elderly, or disabled people will be left alone in the house).
 - Accumulated dust can cause an electric shock, an electric leakage, or a fire by causing the power cord to generate sparks and heat or by causing the insulation to deteriorate.
- Be sure to contact an authorised Samsung service centre for information if you intend to install your TV in a location with heavy dust, high or low temperatures, high humidity, chemical substances, or where it will operate 24 hours a day such as in an airport, a train station, etc. Failure to do so may lead to serious damage to your TV.
- Use only a properly grounded plug and wall outlet.
 - An improper ground may cause electric shock or equipment damage. (Class I Equipment only.)
- To turn off this apparatus completely, disconnect it from the wall outlet. To ensure you can unplug this apparatus quickly if necessary, make sure that the wall outlet and power plug are readily accessible.
- Store the accessories in a location safely out of the reach of children.
- Do not drop or strike the product. If the product is damaged, disconnect the power cord and contact a Samsung service centre.
- To clean this apparatus, unplug the power cord from the wall outlet and wipe the product with a soft, dry cloth. Do not use any chemicals such as wax, benzene, alcohol, thinners, insecticide, aerial fresheners, lubricants, or detergents. These chemicals can damage the appearance of the TV or erase the printing on the product.
- **WARNING - TO PREVENT THE SPREAD OF FIRE, KEEP CANDLES AND OTHER ITEMS WITH OPEN FLAMES AWAY FROM THIS PRODUCT AT ALL TIMES.**
- Use care when touching the TV after it has been on for some time. Some parts can be warm to the touch.



Contents

	Before Reading This Install Guide	2
	Warning! Important Safety Instructions	3
01	What's in the Box?	
	Installing the LED TV Stand	9
	Installing the wall mount kit	11
	Securing the TV to the Wall	11
	Wall Mount Kit Specifications (VESA)	12
	Providing proper ventilation for your TV	12
02	The Samsung Smart Remote	
	About the Buttons on the Samsung SolarCell Remote (Samsung Smart Remote)	13
	Pairing the TV to the Samsung Smart Remote	14
	Charging the battery	14
03	Controlling external devices with a Samsung Smart Remote - Using the Universal Remote	
	Downloading the Universal Remote icon	17
04	Initial Setup	
	Using the TV Controller	19
05	The Connection Panel	
06	Connections	
	Connecting to your Internet network	22
	Connecting the TV to a SBB or STB	24

07	Using a TV Viewing Card (“CI or CI+ Card”)	
	Connecting the “CI or CI+ Card” via COMMON INTERFACE slot with the CI CARD Adapter	25
	Using the “CI or CI+ Card”	26
08	Setting the Hotel Option menu	
	Hotel Option menu items	28
	USB Cloning	35
	Settings Cloned in the Hotel Option menu	36
	Setting Auto Initialize	38
	Updating the TV’s Software	43
09	Editing Channels	
	Using Channel Editor	44
10	Specifications and Other Information	
	Specifications	47
	Environmental Considerations	48
	Decreasing power consumption	48
	Supported Resolutions for UHD Input Signals	49
	Supported Resolutions for Connecting a Computer	50
	Supported Resolutions for Video Signals	52
	Read Before Using the Internet Function	53
	Dimensions	54

01 What's in the Box?

Make sure the following items are included with your TV. If any items are missing, contact your dealer.

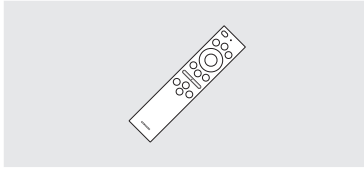

Samsung Smart Remote

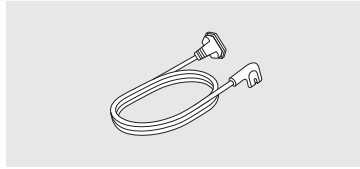

Power Cable

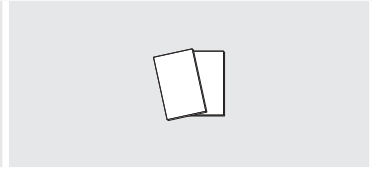

Quick Setup Guide / Warranty Card /
Regulatory Guide / WEEE
(Not available in some locations)

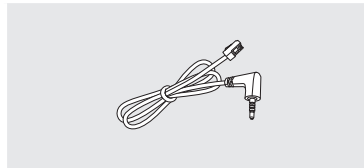

Data Cable

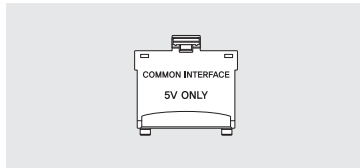

CI Card Adapter

- The items' colours and shapes may vary depending on the models.
- Cables not included can be purchased separately.
- Check for any accessories hidden behind or in the packing materials when opening the box.

An administration fee may be charged in the following situations:

- (a) An engineer is called out at your request, but it is found that the product has no defect (i.e., where the user manual has not been read).
- (b) You bring the unit to a repair centre, but it is found that the product has no defect (i.e., where the user manual has not been read).

You will be informed of the administration fee amount before a technician visits.



The screen can be damaged from direct pressure when handled incorrectly. As shown in the figure, make sure to grip the edges of the screen when you lift the TV.

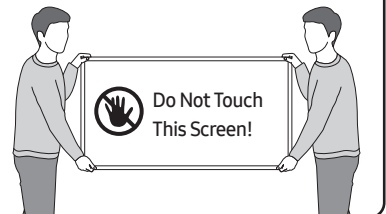



Correct Disposal of This Product (Waste Electrical & Electronic Equipment) (Applicable in countries with separate collection systems)

This marking on the product, accessories or literature indicates that the product and its electronic accessories (e.g. charger, headset, USB cable) should not be disposed of with other household waste at the end of their working life. To prevent possible harm to the environment or human health from uncontrolled waste disposal, please separate these items from other types of waste and recycle them responsibly to promote the sustainable reuse of material resources.

Household users should contact either the retailer where they purchased this product, or their local government office, for details of where and how they can take these items for environmentally safe recycling.

Business users should contact their supplier and check the terms and conditions of the purchase contract. This product and its electronic accessories should not be mixed with other commercial wastes for disposal.



Correct disposal of batteries in this product (Applicable in countries with separate collection systems)

The marking on the battery, manual or packaging indicates that the battery in this product should not be disposed of with other household waste. Where marked, the chemical symbols Hg, Cd or Pb indicate that the battery contains mercury, cadmium or lead above the reference levels in EC Directive 2006/66.

The battery incorporated in this product is not user replaceable. For information on its replacement, please contact your service provider. Do not attempt to remove the battery or dispose it in a fire. Do not disassemble, crush, or puncture the battery. If you intend to discard the product, the waste collection site will take the appropriate measures for the recycling and treatment of the product, including the battery.

Removing the battery

- To remove the battery, contact an authorised service centre. To obtain battery removal instructions, please visit www.samsung.com/global/ecodesign_energy.
- For your safety, you must not attempt to remove the battery. If the battery is not properly removed, it may lead to damage to the battery and device, cause personal injury, and/or result in the device being unsafe.

Following the repair by a non-authorised service provider, self-repair or non-professional repair of the product, Samsung is not liable for any damage to the product, any injury or any other product safety issue caused by any attempt to repair the product which does not carefully follow these repair and maintenance instructions. Any damage to the product caused by an attempt to repair the product by any person other than a Samsung certified service provider will not be covered by the warranty.

Please visit samsung.com/support to find further information about external power adapter and remote control associated with EU Ecodesign directive - ErP regulation

Installing the LED TV Stand

Assembling the Stand and Components

When installing the stand, use the provided components and parts.

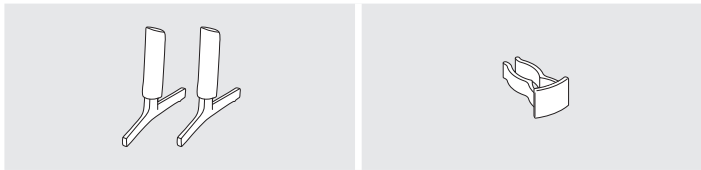

Stand

Holder-Cable x 2

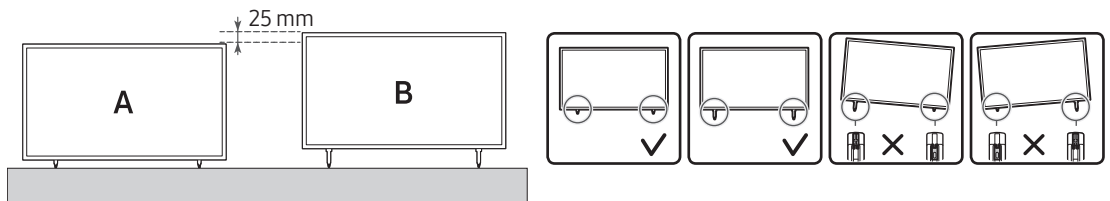

- Place a soft cloth over the table to protect the TV, and then place the TV so that its screen faces down toward the table surface.

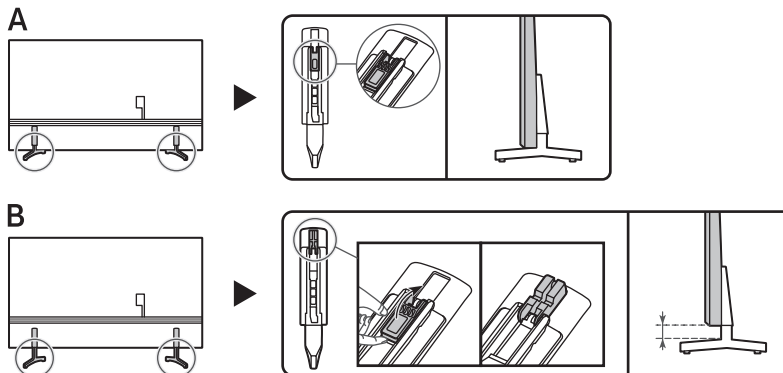

1 43-65"

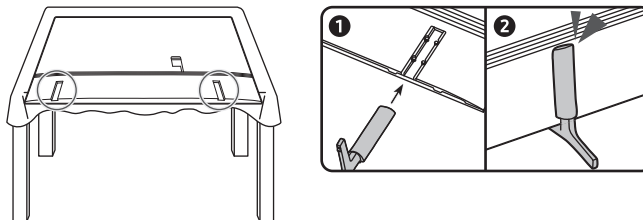

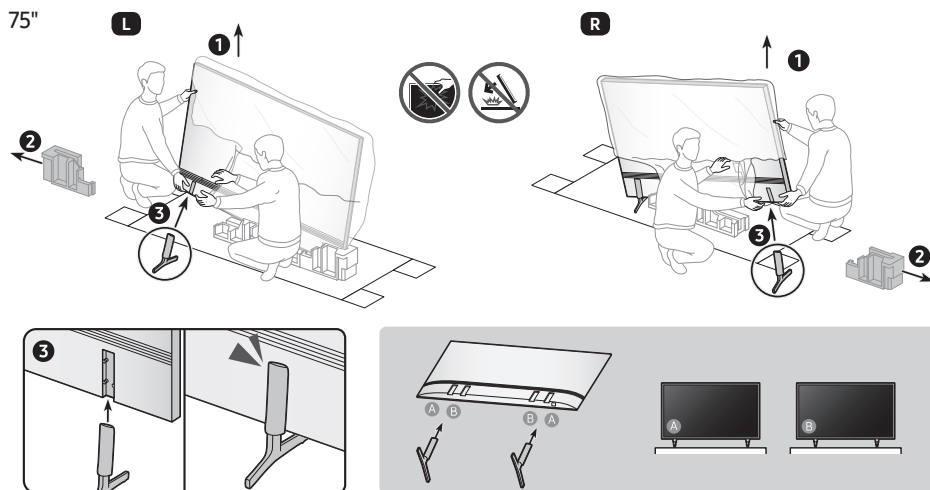

- Insert the Stands into the slot on the bottom of the TV.
- Slide and assemble it to the end line in the direction of arrow.

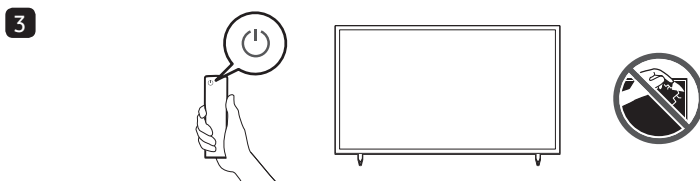
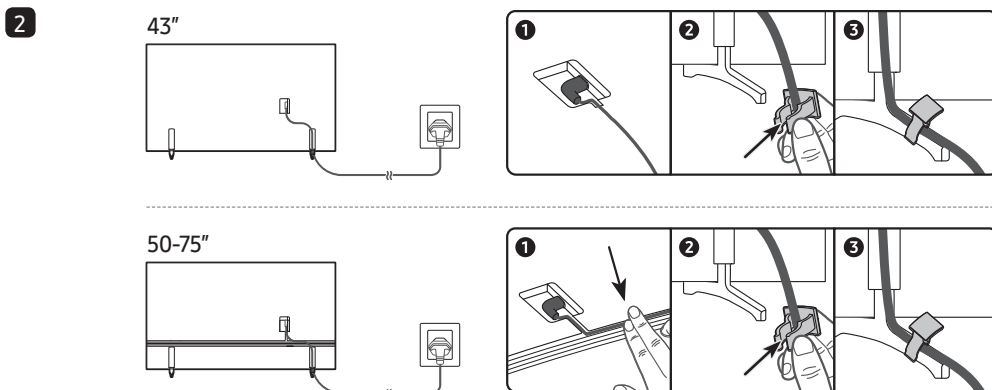

NOTE

- Make sure to distinguish between the front and back of each component when assembling them.
- Make sure that at least two persons lift and move the TV.

Installing the wall mount kit

You can mount the TV on the wall using a wall mount kit (sold separately).

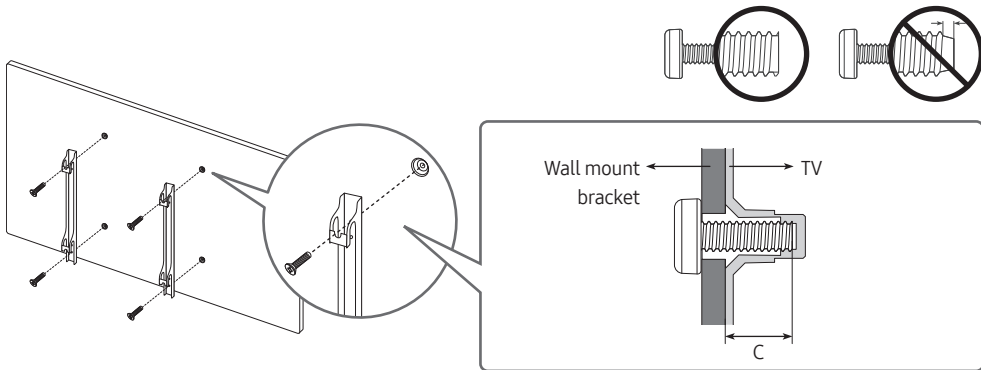

The wall mount kit (sold separately) allows you to mount the TV on a wall.

For detailed information on installing the wall mount, see the instructions provided with the wall mount. Contact a technician for assistance when installing the wall mount bracket. Samsung is not responsible for any damage to the product or injury to yourself or others if you select to install the TV on your own.

Securing the TV to the Wall



Caution: Pulling, pushing, or climbing on the TV may cause the TV to fall. In particular, ensure your children do not hang on or destabilise the TV. This action may cause the TV to tip over, causing serious injuries or death. Follow all safety precautions provided in the Safety Flyer included with your TV. For added stability and safety, you can purchase and install the anti-fall device.

Preventing the TV from falling

1. Using the appropriate screws, firmly fasten a set of brackets to the wall.
Confirm that the screws are firmly attached to the wall.
 - You may need additional material such as wall anchors depending on the type of wall.
2. Using the appropriately sized screws, firmly fasten a set of brackets to the TV.
 - For the screw specifications, refer to the standard screw part in the table under "Wall Mount Kit Specifications (VESA)".
3. Connect the brackets fixed to the TV and the brackets fixed to the wall with a durable, heavy-duty string, and then tie the string tightly.
 - Install the TV near the wall so that it does not fall backwards.
 - Connect the string so that the brackets fixed to the wall are at the same height as or lower than the brackets fixed to the TV.

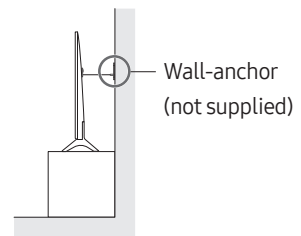
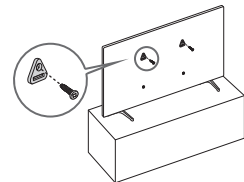

- The product colour and shape may vary depending on the model.

Wall Mount Kit Specifications (VESA)

Install your wall mount on a solid wall perpendicular to the floor. If you are attaching the wall mount to building materials other than plaster board, contact your nearest dealer. If installed on a ceiling or slanted wall, the TV may fall and cause severe personal injury.

- The wall mount kit is not supplied, but sold separately.
- NOTE
 - Standard dimensions for wall mount kits are shown in the table below.
 - Samsung wall mount kits contain a detailed installation manual. All parts necessary for assembly are provided.
 - Do not use screws that do not comply with the VESA standard screw specifications.
 - Do not use screws that are longer than the standard dimension or do not comply with the VESA standard screw specifications. Screws that are too long may cause damage to the inside of the TV set.
 - For wall mounts that do not comply with the VESA standard screw specifications, the length of the screws may differ depending on the wall mount specifications.
 - Do not fasten the screws too firmly. This may damage the product or cause the product to fall, leading to personal injury. Samsung is not liable for these kinds of accidents.
 - Samsung is not liable for product damage or personal injury when a non-VESA or non-specified wall mount is used or the consumer fails to follow the product installation instructions.
 - Do not mount the TV at more than a 15 degree tilt.
 - Always have two people mount the TV onto a wall.

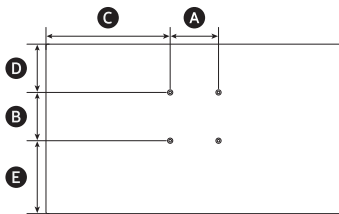

TV size in inches	VESA screw hole specs (A * B) in millimetres	C (mm)	D (mm)	E (mm)	C (mm)	Standard Screw	Quantity
43	200 x 200	382.8	192.2	167.7	11-13	M8	4
50		459.2	207.4	237.2			
55		516.1	239.3	269.5			
65		525.5	264.0	267.9			
75	400 x 300	638.4	259.6	300.7			



Do not install your wall mount kit while your TV is turned on. This may result in personal injury from electric shock.

Providing proper ventilation for your TV

When you install your TV, maintain a distance of at least 10 cm between the TV and other objects (walls, cabinet sides, etc.) to ensure proper ventilation. Failing to maintain proper ventilation may result in a fire or a problem with the product caused by an increase in its internal temperature.

- When you install your TV with a stand or a wall mount, we strongly recommend you use parts provided by Samsung only. Using parts provided by another manufacturer may cause difficulties with the product or result in injury caused by the product falling.

02 The Samsung Smart Remote

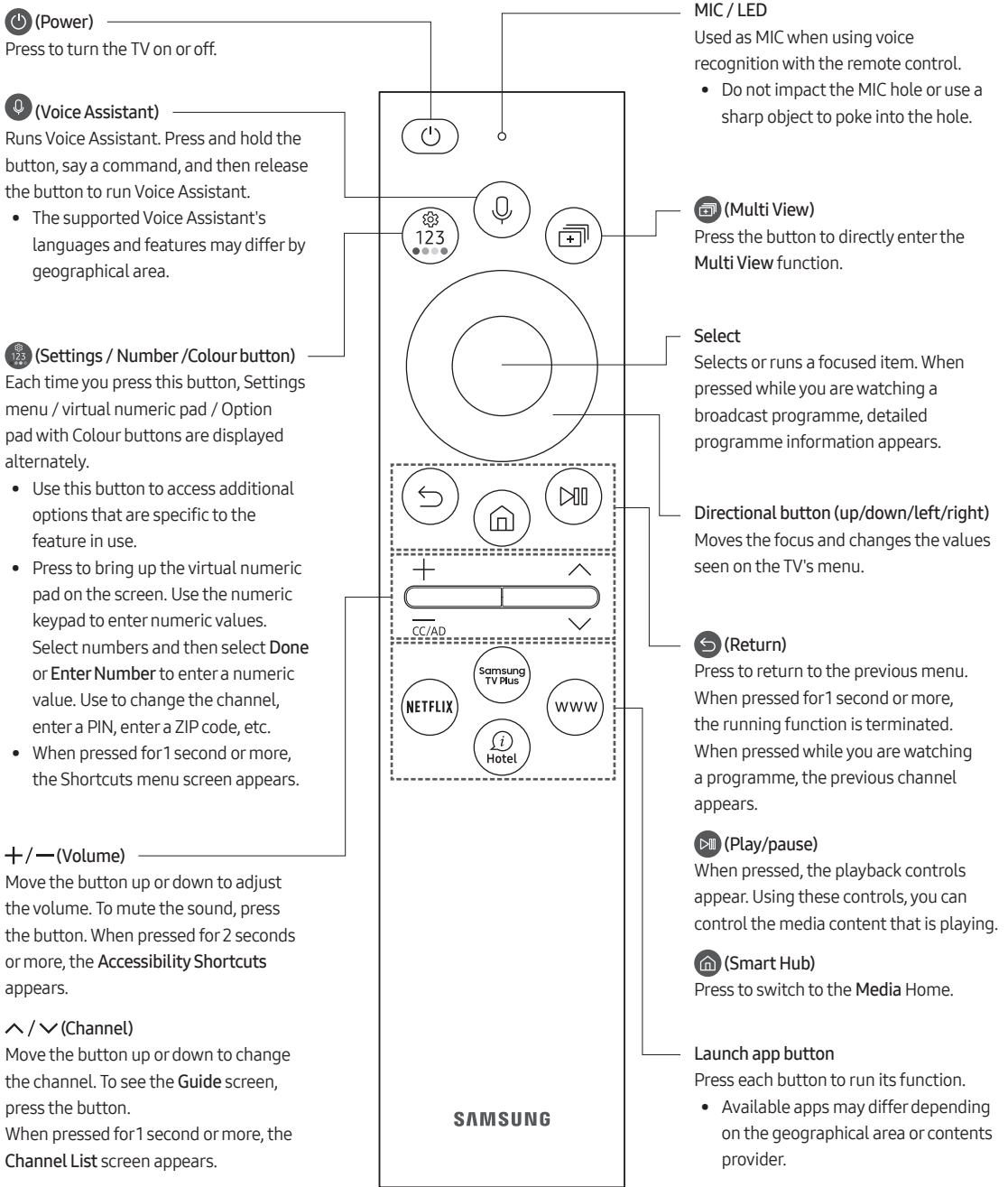

About the Buttons on the Samsung SolarCell Remote (Samsung Smart Remote)

- The images, buttons, and functions of the Remote Control may differ with the model or geographical area.
- The Universal Remote function operates normally only when you use the Samsung Smart Remote that comes with the TV.
- A button without a description in the image below is not supported on the product.

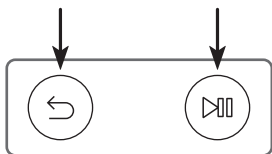

Pairing the TV to the Samsung Smart Remote



When you turn on the TV for the first time, the Samsung Smart Remote pairs to the TV automatically. If the Samsung Smart Remote does not pair to the TV automatically, point it at the remote control sensor of the TV, and then press and hold the buttons labelled  and  as shown in the figure on the left simultaneously for 3 seconds or more.

Charging the battery

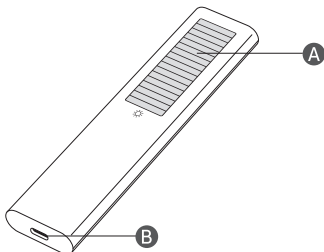

A Solar Cell

Expose to light when the remote is not in use. This will extend the remote's operating time.

B USB port (C-type) for charging

Used for quick charging. The LED on the front will light when charging. When the battery is fully charged, the LED will turn off.

- The USB Cable is not provided.

- It is recommended to use an original Samsung charger. Otherwise, it may cause performance degradation or failure of the product. In this case, the warranty service is not applicable.
- When the remote control does not work due to low battery, charge it by using the USB-C type port.
- Battery consumption may differ depending on the usage environment.



Fire or explosion may occur, resulting in damage to the remote control or personal injury.

- Do not apply shock to the remote control.
- Be careful not to let foreign substances such as metal, liquid, or dust come in contact with the charging terminal of the remote control.
- When the remote control is damaged or you smell smoke or burning fumes, immediately stop operation and then repair it at the Samsung service centre.
- Do not arbitrarily disassemble the remote control.
- Be careful not to let infants or pets suck or bite the remote control. Fire or explosion may occur, resulting in damage to the remote control or personal injury.



THE PLASTIC PART OF 22
SMART CONTROL CONTAINS A
MINIMUM OF 24% POST-
CONSUMER RECYCLED
PLASTIC
UL.COM / ECV

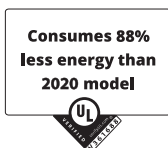

03 Controlling external devices with a Samsung Smart Remote - Using the Universal Remote

You can control external devices connected to the TV using a Samsung Smart Remote. To control external devices, register them by following instructions.

- The images on your TV may differ from the images accompanying the instructions depending on the model and geographical area.



1. Go to the **Hotel Option** menu, and then select **Universal Remote Setting**. The **Universal Remote Setup** screen appears.
 - **Hotel Option** menu > **Universal Remote** > **Universal Remote Setting**

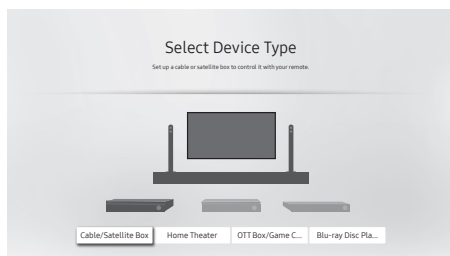

2. If the TV is connected to a set-top box, select **Cable/Satellite Box**.

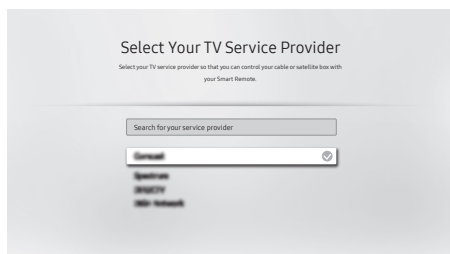

3. Select your service provider from the list in the screen. If your service provider is not listed, search manually.

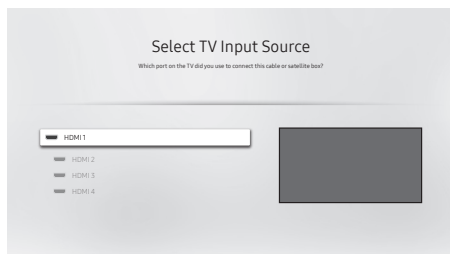

4. Select the HDMI port on the TV to which the set-top box is connected.

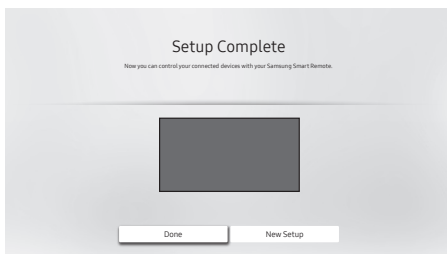
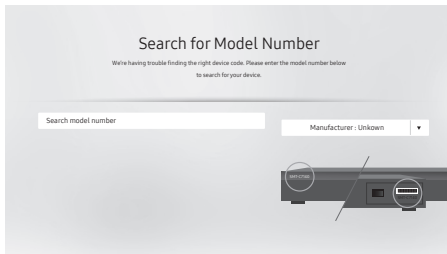
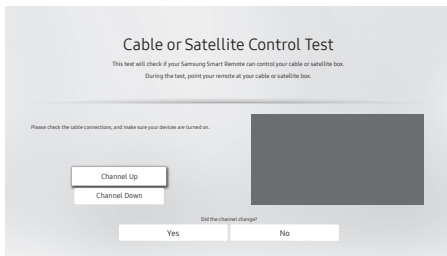

5. Press the CH button on the remote control according to the instructions on the screen in order to test whether the TV and the set-box operate correctly when you press the remote control buttons.
 - If the TV and the set-box operate correctly, select **Yes**. The setup is completed. Go to step 7.
 - If the TV and the set-box do not operate correctly, select **No**. Go to step 6.
6. Follow the instructions on the screen to search for the model number of the set-top box connected to the TV. When the model number is found, repeat step 5 for the operation test.
7. When you have completed all the settings, select **Done** in the following screen:

- This function may not be supported depending on the model or geographical area.
- You can also use the **Anynet+ (HDMI-CEC)** function to operate external Samsung devices with your TV's remote control without any additional setup.
- Specific external devices connected to the TV may not support the universal remote feature.
- Do not place any obstacles in front of an external device and TV's logo. It may cause signals from the remote control to be transmitted improperly.
- The TV memorises both the external device and its connection port (HDMI 1, HDMI 2, etc.).

Downloading the Universal Remote icon

1. Store the following files in the root directory of your USB device:

	File name	File type	File Size
App tile	stb_app_icon	jpg, png	245 x 138, 2MB
Source icon	stb_source_icon	jpg, png	66 x 66 to 135 x 135, 2MB

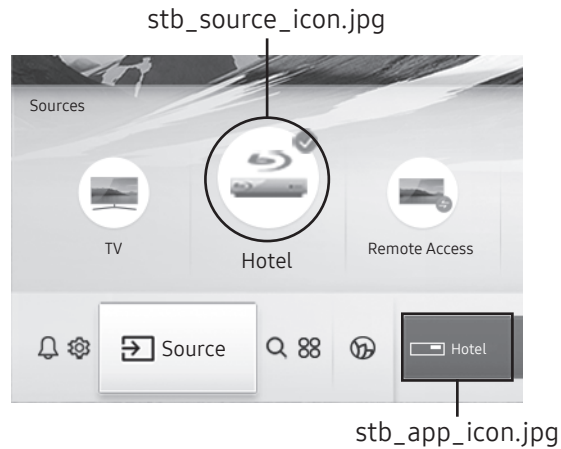

- The image on your TV may differ from the image above depending on the model and geographical area.

2. Go to the **Hotel Option** menu, and then select **Universal Remote Icon DL**.

- **Hotel Option** menu > **Universal Remote** > **Universal Remote Icon DL**
- The **Universal Remote Icon DL** is only available after you have completely set up the Universal Remote.

04 Initial Setup

When you turn on your TV for the first time, it immediately starts the Initial Setup. Follow the instructions displayed on the screen and configure the TV's basic settings to suit your viewing environment.

If you already completed the Initial Setup, run the Initial Setup again using the following menu.

- **Hotel Option** menu > **System** > **TV Reset**

If you select **TV Reset**, the TV resets all values to their factory defaults. When the TV turns off, press the **Power** button on the remote control to turn on the TV. The TV starts the Initial Setup.

- The Initial Setup steps may differ with the model or geographical area.

Select the region settings

- 1
 - Before select region, refer to the country list information on the right.
 - If you select the incorrect region, execute **TV Reset** again after the Initial Setup is completed.
 - If the region is changed, the TV automatically turns off and on.

Selecting your TV installation type

- 2
 - **Basic TV Setup:** Select to proceed to the next step to set the basic options for using your TV.
 - **Cloning Mode:** Copy the system settings from the USB or server to the TV.
 - **Factory Menu:** End Initial Setup and go to **Hotel Option** menu directly.

-
- Follow the instructions on the screen to configure the settings for your own viewing environment.

Using the TV Controller

You can turn on the TV with the **TV Controller** button at the bottom of the TV, and then use the **Control menu**. The **Control menu** appears when the **TV Controller** button is pressed while the TV is On. For more information about its usage, refer to the figure below.

- The screen may dim if the protective film on the SAMSUNG logo or the bottom of the TV is not detached. Please remove the protective film.

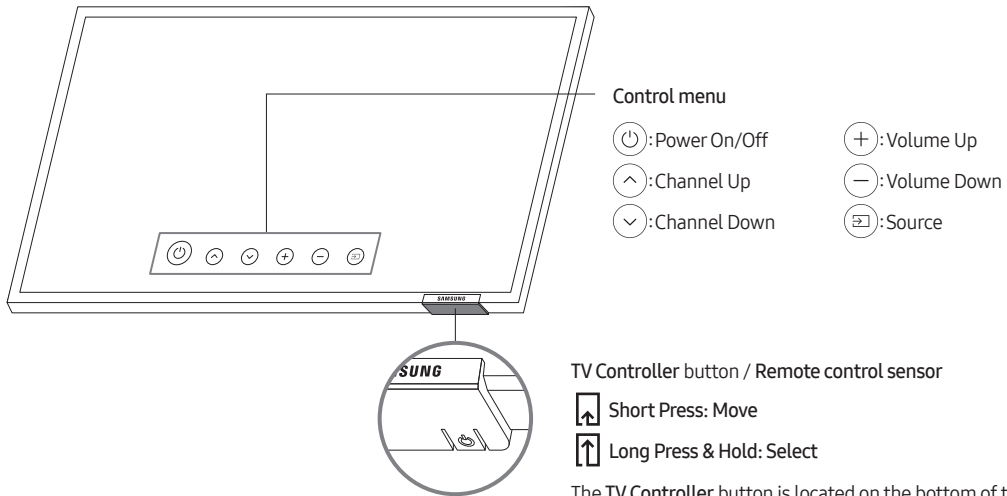

The TV Controller button is located on the bottom of the TV.

05 The Connection Panel

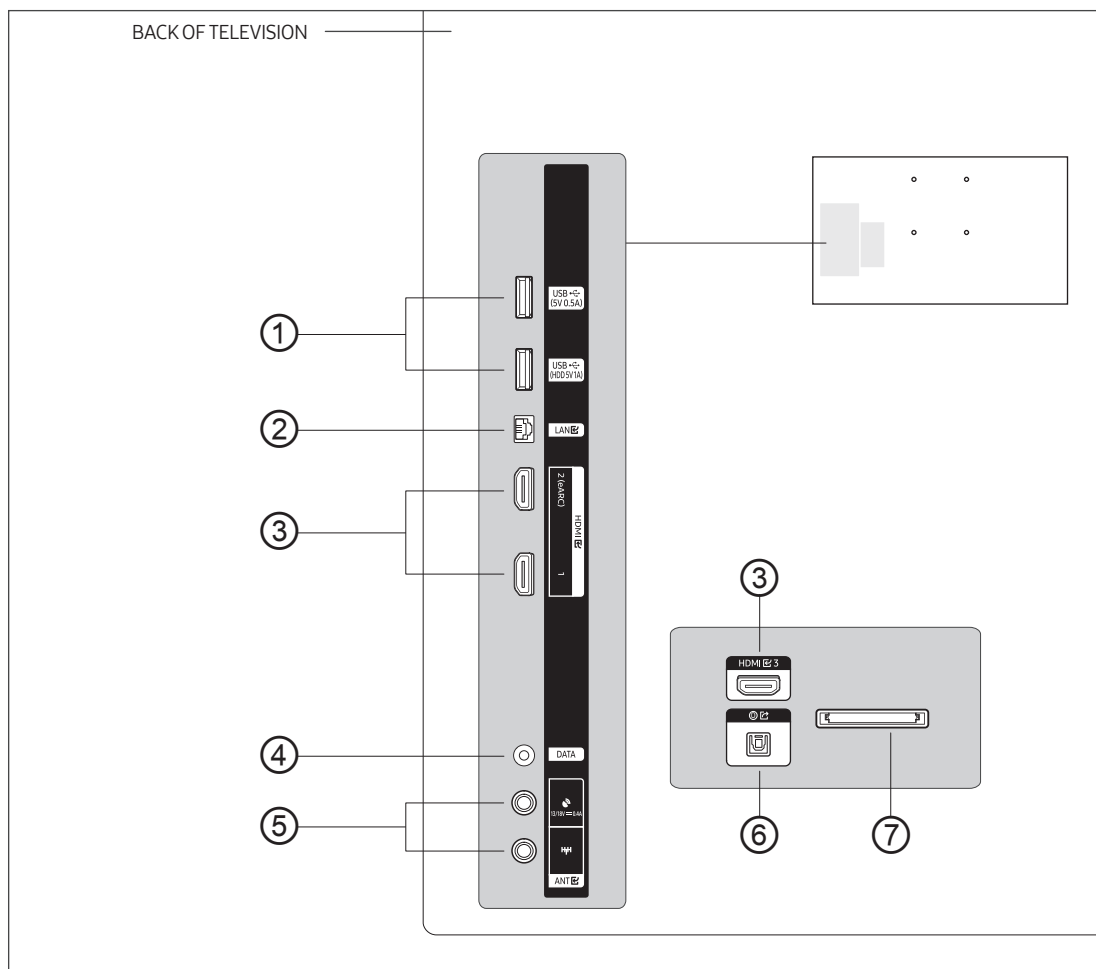

- When connecting an external device, match the colour of the connection port to the cable.
- Whenever you connect an external device to your TV, make sure that power on the TV and the device is turned off.

① USB (5V 0.5A), USB (HDD 5V1A)

- Connector for software upgrades and Media Play, etc.
- Service connection.

② LAN

To connect a LAN cable, use a CAT 7 (*STP type) cable for the connection. (100/10 Mbps)

* Shielded Twisted Pair

③ **HDMI IN 1, 2 (eARC), 3**

Connects to the HDMI jack of a device with an HDMI output.

- No separate sound connection is needed for an HDMI to HDMI connection. HDMI connections carry both audio and video.
- It is recommended that the external device of the HDMI 1.3 or 1.4 version will be used with this TV. If you meet the compatible problem like no sound or the abnormal screen or etc with the device of the HDMI 1.2 version, contact to the Samsung customer care centre.

④ **DATA**

- Used to support data communication between the TV and the SBB or STB.
- Connects using RJ-12 TV type plugs.

⑤ **ANT IN (SATELLITE), (Aerial/CABLE)**

To view television channels correctly, the TV must receive a signal from one of the following sources:

- An outdoor antenna / A cable television system / A satellite receiver

⑥ **DIGITAL AUDIO OUT (OPTICAL)**

Connects to a Digital Audio component.

⑦ **COMMON INTERFACE**

Watches paid channels by inserting your TV viewing card ("CI or CI+ Card") into the COMMON INTERFACE slot.

06 Connections

Connecting to your Internet network

You can set up your TV so that it can access the SMART TV applications through your local area network (LAN) using a wired or wireless connection.

- After you have physically connected the TV to your network, you must configure the network connection to complete the process. You can configure the connection after the Initial Setup process, through the TV's menu (Hotel Option menu > Smart Service > Network Setup > (Open Network Settings > Wireless or Wired).

Establishing a wireless Internet connection

Connect the TV to the Internet using a wireless access point or modem.

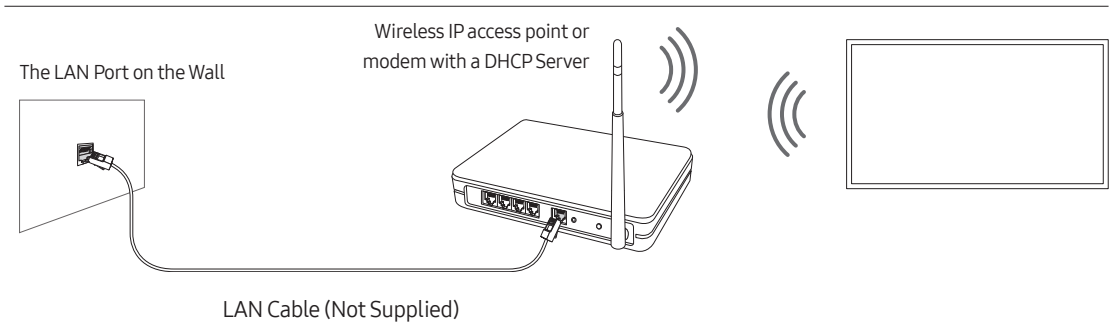

- This TV supports the IEEE 802.11 a /b /g /n /ac communication protocols. Samsung recommends using IEEE 802.11n. Otherwise, when you play video over a network connection, the video may not play smoothly.
 - Some of the IEEE 802.11 communication protocols may not be supported depending on the model or geographical area.
- To use a wireless network, the TV must be connected to a wireless access point or modem. If the wireless access point supports DHCP, the TV can use a DHCP or static IP address to connect to the wireless network.
- Select a channel that is not currently in use for the wireless access point. If the channel set for the wireless access point is currently being used by another device, the result is usually interference and/or a communications failure.
- Most wireless networks have an optional security system. To enable a wireless network's security system, you need to create a security key using characters and numbers, and then enter that key into the access point through its menu. You then must enter this security key into any other devices you want to connect to the wireless network.

Network Security Protocols

The TV only supports the following wireless network security protocols:

- Authentication Modes: WEP, WPAPSK, WPA2PSK
- Encryption Types: WEP, TKIP, AES

In compliance with the Wi-Fi certification specifications, Samsung TVs do not support WEP or TKIP security encryption in networks running in the 802.11n mode.

If the wireless access point supports WPS (Wi-Fi Protected Setup), you can connect the TV to your network using PBC (Push Button Configuration) or a PIN (Personal Identification Number). WPS automatically configures the SSID and WPA key settings.

Your Smart TV cannot connect to uncertified wireless access point.

Establishing a wired Internet connection

There are three main ways to connect the TV to your network using cable, depending on your network setup. They are illustrated below:

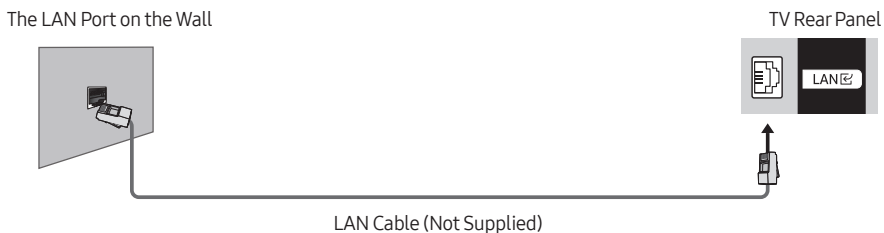
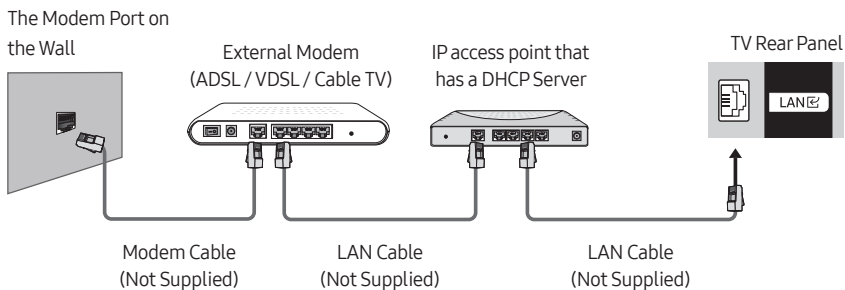
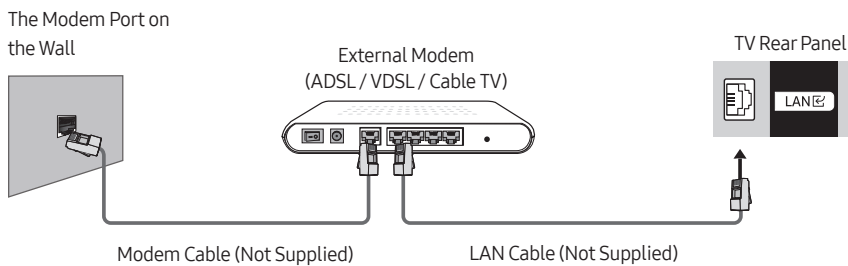

- The TV will not be able to connect to the Internet if your network speed is below 10 Mbps.
- To connect a LAN cable, use a CAT 7 (*STP type) cable for the connection. (100/10 Mbps)
 - * Shielded Twisted Pair

Connecting the TV to a SBB or STB

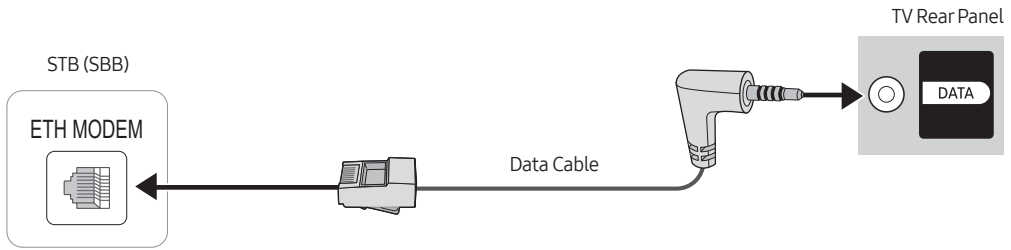

Connect the **DATA** port of the TV to the **ETH MODEM** port of the STB (SBB) with the Data cable.

- The **ETH MODEM** port name that you connect the Data Cable to may differ depending on the SBB or STB type.
- IR signals sent by the remote control to the TV or SBB / STB must meet the following specification to use IR pass through function.

IR signal receiver specification

- Band pass filter centre frequency: 37.9 kHz
- Carrier Frequency, Duty 50%
- Minimum Burst Length (tburst): 12 pulses (316 us)
- Minimum Gap Time Between the burst (tburst gap): 16 pulses (422 us)
- Minimum Gap Time between the data commands (tpause): 25 ms

List of Hospitality SI Vendors and compatible data cables supplied with the TV

- Confirm you are using the correct data cable for your SI vendor. Refer to the code label on the data cables.
- Contact your nearest dealer or your SI Vendor to buy the data cable not included in the TV.

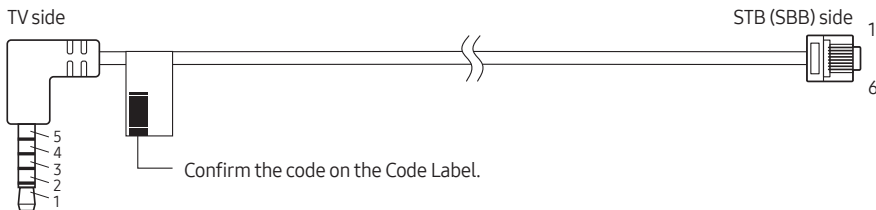

Cable code	Pin assign	Remark
BN39-02462A (Colour: BLACK)	<div style="display: flex; justify-content: space-around;"> <div style="border: 1px solid black; padding: 5px;"> <p>TV SIDE</p> <p>1: TX 2: RX 3: IR 4: NC 5: GND</p> </div> <div style="border: 1px solid black; padding: 5px;"> <p>P1 P2</p> <p>1 RED 3 2 GREEN 5 3 WHITE 6 4 BLACK 1 5 YELLOW 2</p> </div> <div style="border: 1px solid black; padding: 5px;"> <p>STB (SBB) SIDE</p> <p>1: NC 2: GND 3: TX 4: NC 5: RX 6: IR</p> </div> </div>	SAMSUNG and others

- RX and TX notation is based on TV.
- Operation Specification of Data Cable(RJ12): RS232

07 Using a TV Viewing Card (“CI or CI+ Card”)

Watches paid channels by inserting your TV viewing card (“CI or CI+ Card”) into the COMMON INTERFACE slot.

- The 2 CI card slots may not be supported depending on the model.
- Turn the TV off to connect or disconnect a “CI or CI+ Card”.
- The “CI or CI+ Card” may not supported depending on the model.

Connecting the “CI or CI+ Card” via COMMON INTERFACE slot with the CI CARD Adapter

Attaching the CI CARD Adapter via COMMON INTERFACE slot

To attach the CI CARD Adapter to the TV, follow these steps:

- ① Insert the CI CARD Adapter into the two holes on the back of TV.
 - Please locate the two holes at the back of the TV above the COMMON INTERFACE slot.
- ② Connect the CI CARD Adapter to the COMMON INTERFACE slot on the back of TV.

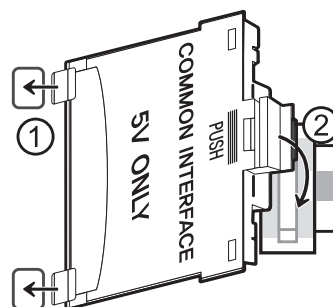

Connecting the “CI or CI+ Card”

Connect the “CI or CI+ Card” to the COMMON INTERFACE slot as shown in the image below.

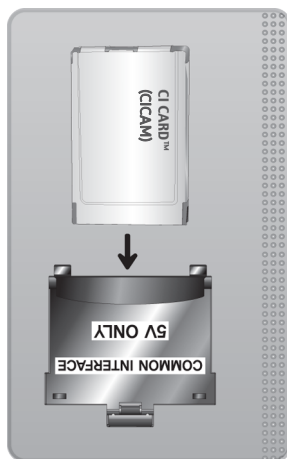

Using the “CI or CI+ Card”

To watch paid channels, the “CI or CI+ CARD” must be inserted.

- Samsung TV follow up CI+ 1.4 standard. When Samsung TV product display the pop-up message, it may happen due to CI+ 1.4 Version inconsistency. If you have a problem, please contact Samsung Call Centre.
 - Your Samsung TV conforms to the CI+ 1.4 standards.
 - Where a CI+ Common Interface module is incompatible with Samsung TV then please remove the module and contact the CI+ operator for assistance.
- If you don't insert the “CI or CI+ CARD”, some channels will display the pop-up message.
- The Pairing information will be displayed in about 2-3 minutes. If an error message is displayed, please contact your service provider.
- When the configuration of channel information has finished, the message “Updating Completed” is displayed, indicating the channel list is updated.
- You must obtain a “CI or CI+ CARD” from a local cable service provider.
- When removing the “CI or CI+ CARD”, carefully pull it out with your hands since dropping the “CI or CI+ CARD” may cause damage to it.
- Insert the “CI or CI+ CARD” in the direction marked on the card.
- The location of the COMMON INTERFACE slot may be different depending on the model.
- “CI or CI+ CARD” are not supported in some countries and regions. check with an authorised dealer to find out if “CI or CI+ CARD” are supported in your locality.
- If you have any problems, please contact a service provider.
- Insert the “CI or CI+ CARD” that supports the current aerial settings. If not, the screen may not look normal.

08 Setting the Hotel Option menu

To access the **Hotel Option** menu, press the following buttons on the remote control:

1. Press the **+/-** button.
2. Press the up directional button.
3. Press the down directional button.
4. Press the **Select** button.

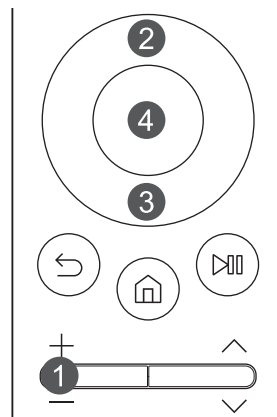

To control the TV functions in the **Hotel Option** menu, the TV has the **Standalone** mode.

- **SI Vendor: OFF / Movielink / Swisscom / SSCP**

After a menu appears, follow these general directions to navigate and change values:

- Use the directional buttons on the remote control to move from menu item to menu item.
- Press the **Select** button on the remote control to select a menu item. The screen displays that menu item only.
- Press the left or right directional button to change a value. The right directional button increases numerical values. The left arrow button decreases numerical values.
- When the screen is displaying one menu item, you can press the up or down directional button to display the next or previous menu item.
- Press the **↶** button to exit the current menu item and go to a higher menu level.
- To exit a **Hotel Option** menu, turn off the TV, and then turn it on again. Any changes you made are saved except changes to SI (System Integration) vendor. For changes to SI vendor, you must turn the TV off, wait until the power indicator at the bottom of the TV glows steadily. And then unplug the TV's power cord, wait for the power indicator to go off, and then plug the TV's power cord in again.

Hotel Option menu items

To exit from this menu, turn off (or turn off and unplug the power cable if you have changed SI vendor) the TV, and then turn on again. Any changes you made are saved.

- The menu items may not be supported depending on the model or geographical area.

Hotel Option menu Item		Description
Hospitality Mode		Select Hospitality Mode . <ul style="list-style-type: none"> • Interactive: TV works with an SI STB or SBB. • Standalone: TV works alone, without an SI STB or SBB.
SI Vendor		<ul style="list-style-type: none"> • Interactive: Samsung / 2M / Locatel / VDA / VDA-S / Acentic / Sustinere / Quadriga / ETV / IBahn / Magilink / Otrum / Siemens / Amino / MDC / Enseo • Standalone: OFF / Movielink / Swisscom / SSCP
SI Config	MDC ID Settings	This function is only available when set to Hospitality Mode: Interactive , SI Vender: MDC .
	TV Version	This function is only available when set to Hospitality Mode: Interactive , SI Vender: Magilink .
Power On	Power On Channel	Set the channel to display when the TV is turned on. <ul style="list-style-type: none"> • User Defined: Lets you set the channel number manually on Power On Channel Num. See Power On Channel Num below. • Last Saved: If you select this item, when the TV is turned on, it displays the channel it was displaying when it was turned off.
	Power On Channel Num	When the TV is turned on, it switches automatically to this channel.
	Power On Channel Type	Select the type of the channel will be displayed when the TV is turned on. ATV (analog air band), DTV (digital air band), CATV (analog cable band), CDTV (digital cable band), SDTV (For Satellite Models), IPTV (IP channel, IPTV is set when deployed from solution.)
	Power On Volume	Set volume level when the TV is turned on. <ul style="list-style-type: none"> • User Defined: Lets you set volume level manually. • Last Saved: When the TV is turned on, it returns to the volume that had been set when the power had been turned off.
	Power On Volume Num	The TV turns on with set volume level in Standalone mode.
	Min Volume	The minimum volume level the user can set in Standalone mode.
	Max Volume	The maximum volume level the user can set in Standalone mode.
	Power On Source	Select the input source to be displayed when the TV is turned on.
	Power On Option	Determines the TV's state when power returns after a power failure or after you have unplugged the TV and then plugged it in again. <ul style="list-style-type: none"> • Power ON: When the power returns, the TV turns on. • Standby: When the power returns, the TV enters the standby mode. • Last Option: Returns to its last power state. If it was in standby mode, it returns to standby mode. If it was on, it turns on.

Hotel Option menu Item	Description	
Channel	Channel Setup	Gives you direct, immediate access to some of the channel menu functions on the Broadcasting menu such as Audio Options , Service Provider etc.
	Channel Editor	<p>Lets you edit the channels stored in the TV's memory.</p> <ul style="list-style-type: none"> • Change the channel numbers and names, manage genre and language groups and delete channels. • Apply the Screen Off to channels you select. The Screen Off blanks out the video from a channel and outputs only audio. • Lets you view information about each channel easily, without your having to display each channel directly.
	Mixed Channel Map	<p>Enables showing/browsing all antenna type (Aerial/Cable) channels at the same time.</p> <ul style="list-style-type: none"> • ON: When set to on, guests can access the complete channel map irrespective of the selected antenna type. The Channel List/Channel Editor will also populate Aerial as well Cable type channels. • OFF: When set to off, guest can access the channel map corresponding to the selected antenna type (Aerial/Cable) only. The Channel List/Channel Editor will only show the selected antenna type channels.
	Dynamic SI	<ul style="list-style-type: none"> • ON: Do not check the DTV programme channel number. • OFF: Check the DTV programme channel number.
	Channel Rescan Message	<p>When there is a mismatch between the data in the channel map and the transmitted data, the TV autotunes the channels to restore the data/parameters in the channel map.</p> <ul style="list-style-type: none"> • ON: When Channel Rescan Message is set to on, the OSD showing that the channels are being rescanned will be displayed to the guest. • OFF: When Channel Rescan Message is set to off, if the rescan message OSD should not to be displayed to the guests.
	MyChannel	<p>Enable or disable the MyChannel function.</p> <ul style="list-style-type: none"> • This function is available when set to Hospitality Mode: Standalone.
	Subtitle Auto On	<p>This function turns the function on or off that automatically turns on the subtitles in a specific country.</p> <p>This function is supported for the TVs that are ready to receive DVB broadcasts that is heading to Europe.</p> <p>This function is related to France's subtitle specification. The rest of the subtitle functions available according to the country specifications regardless of Subtitle Auto On function.</p> <ul style="list-style-type: none"> • ON: When Subtitle Auto On is set to on, it follows France's subtitle specifications. • OFF: When Subtitle Auto On is set to off, it does not follow France's subtitle specifications.
	TTX Widescreen Mode	<ul style="list-style-type: none"> • ON: TTX should show in 16:9 picture size. • OFF: TTX should show in 4:3 picture size.

Hotel Option menu Item		Description
Menu OSD	Picture Menu Lock	ON or OFF the Picture menu.
	Menu Display	<ul style="list-style-type: none"> • ON: The main menu is displayed. • OFF: The main menu is not displayed.
	Channel Menu Display	<ul style="list-style-type: none"> • ON: Broadcasting menu is enable for guest. • OFF: Broadcasting menu is disable for guest.
	Panel Button Lock	Turning the TV Controller button operations on or off. <ul style="list-style-type: none"> • Unlock: Unlocks TV Controller button. • Lock: Locks TV Controller button. • OnlyPower: Locks TV Controller button except the power off function.
Clock	Local Time	Select the way to update the clock data <ul style="list-style-type: none"> • Standalone: Manual / Time Channel / TTX • Interactive: Manual / Time Channel / TTX / Auto – Manual: The clock is set manually by the user when the TV is in Standalone mode. – Auto: The clock is set automatically when the TV is in Interactive mode. – Time Channel: The clock is set from the selected channel. – TTX: Bring up the time information from the TTX stream.
	Time Channel Type	Select the type of the channel to update the clock data. DTV (digital air band), CDTV (digital cable band), SDTV <ul style="list-style-type: none"> • This function is only available Local Time set to Time Channel.
	Time Channel Num	Select the number of the channel to update the clock data. <ul style="list-style-type: none"> • This function is only available Local Time set to Time Channel.
External Source	USB Pop-up Screen	When USB is connected to the TV : <ul style="list-style-type: none"> • Automatic: This enters the USB content menu automatically. • Disable: Neither the popup window nor the menu appears.
Power and Energy Saving	Brightness Reduction	<ul style="list-style-type: none"> • ON: Turns on the energy saving function. • OFF: Turns off the energy saving function.
	Power Saving Mode Timer	This function is only available when set to Hospitality Mode: Interactive, SI Vender: Magilink .
Cloning	Clone TV to USB	Clone the current TV options to a USB device.
	Clone USB to TV	Clone the saved TV options on a USB device to the TV.
	Setting Auto Initialize	If you set Setting Auto Initialize to On , the TV menu items are restored again to their values cloned initially when the TV turns off and then on.

Hotel Option menu Item		Description
Smart Service	Network Setup	Run the Network menu to configure your TV's network settings. You can set the following items: <ul style="list-style-type: none"> • Network Status: View the current network and Internet status. • Open Network Settings: Connect to an available network. • Reset Network: Restore the network settings to the factory default. • Expert Settings: Configure advanced network settings.
	Download by App ID	Enter the App ID. Only a registered ID can be entered.
	Apps Editable	Provide a way to enable or disable the Apps and Notification Settings menu. <ul style="list-style-type: none"> • ON: Enable the Apps and Notification Settings menu. • OFF: Disable the Apps and Notification Settings menu.
	Ambient Editable	Provide a way to enable or disable the Ambient Settings menu in Ambient Mode . <ul style="list-style-type: none"> • ON: Enable the Ambient Settings menu. • OFF: Disable the Ambient Settings menu.
	Terms & Policy	View the entire text of the Terms & Policy document. <ul style="list-style-type: none"> • You must agree to the Smart Hub service agreement.
	Smart Features	Run the Smart Features menu. <ul style="list-style-type: none"> • Autorun Smart Hub: If Autorun Smart Hub is set to On, the TV automatically displays the Home Screen when you turn on the TV.
	Quick Settings Editor	Edit the items to be displayed in Quick Settings and change their order.
	Samsung Account	Create and manage your own Samsung account.
Universal Remote	Universal Remote Setting	Run the Universal remote setup function.
	Universal Remote Type	This function is only available when set to Hospitality Mode: Interactive, SI Vender: Samsung .
	Universal Remote Icon DL	Lets you download Universal Remote icons from USB device and applying downloaded icons to the connected Universal Remote source.

Hotel Option menu Item	Description	
Security	Factory Lock	Disable entry to Hotel Option menu. <ul style="list-style-type: none"> • ON: The password is needed before entering Hotel Option menu. • OFF: Disable this function.
	Password Popup	Enable or disable password input popup window. If this option is set to off, the TV will not display the password input popup window when entering the Hotel Option menu. If set to ON , the password input popup window appears.
	Password Input	If this function is enabled, the password input popup window appears which asks for an 8-character security password. The admin must enter a password before applying or updating security preferences. After the correct password is entered, options such as Password Setting , Password Reset and Security Mode are available.
	Password Setting	User can change the password.
	Password Reset	Password is reset to "00000000."
	Security Mode	Provides password protected administrative functionality to enable or disable features of hospitality TV, such as USB , HDMI . To use this option, Security Mode set to ON . After Security Mode set to ON , options such as USB , HDMI are automatically enabled.
	USB	Enable or disable USB access. If this function is set to Disable , access to USB media is blocked. Clone USB to TV and TV Reset will be disabled in the Hotel Option menu.
	HDMI	Enable or disable HDMI access. If this function is set to Disable , Anynet+, HDMI source, HDMI type external channels will not be accessible to the user.
TTX Security	If this option is set to Disable , the TTX feature will not work even if you press the  button on the remote control and then select TTX/MIX .	
DRM	DRM Mode <p>Configures DRM support.</p> <ul style="list-style-type: none"> • OFF: Turns off DRM support. • LYNK DRM: Select to turn on LYNK CAS support only. 	

Hotel Option menu Item	Description
System	<p>Self Diagnosis for HTV</p> <p>Lets you check the state of Pro:Idiom and its communication with the SI STB or SBB. If you have any problems with the Pro:idiom encryption channel or the communications with the SI STB or SBB, use this diagnosis function. If PI DTV Channel Key Loss (Pro:Idiom DTV Channel Key Loss) appears to have failed and the Pro:Idim encryption channel has failed to play content, first check the broadcasting systems related to Pro:Idiom encryption. If your broadcasting system does not have a problem, contact Samsung Service. If STB SI Vendor Setting appears to have failed and communication with the SI STB or SBB has failed, first check your SI STB or SBB. If your SI STB or SBB does not have a problem, contact to Samsung Service.</p>
	<p>Self Diagnosis for TV</p> <p>Run the Device Care menu.</p> <ul style="list-style-type: none"> • Video Test: Use this test when you experience a problem with your TV's video. • Smart Hub Connection Test: Use this test when you experience a problem with your TV's smart hub. • HDMI Troubleshooting: Use this test when you experience a problem with your TV's HDMI connection. • Start Picture Test: Use this test when you experience a problem with your TV's picture. • Start Sound Test: Use this test when you experience a problem with your TV's sound. • Signal Information: Show digital broadcasting signal information. • Reset Smart Hub: Reset the Smart Hub and Samsung account settings stored on your TV.
	<p>System Manager</p> <p>Gives you direct, immediate access to System Manager functions such as Time, Language, Change PIN. System Manager allow you to adjust your TV's system and customise settings for your viewing environment.</p>
	<p>OTN Update</p> <p>Lets you upgrade the TV Software over the network when a valid upgrade file is present on server.</p> <ul style="list-style-type: none"> • OTN Update changed to ON and disabled when Enrollment Status in LYNK Cloud is Yes.
	<p>SW Update</p> <p>Lets you upgrade the TV Software with a USB device.</p>
	<p>Remote Management</p> <p>Provide remote diagnostic service from Samsung call centre.</p> <ul style="list-style-type: none"> – Need to agree to the terms and conditions.
	<p>About This TV</p> <p>Display the Samsung web site, and product and software information.</p>
	<p>Standby LED</p> <p>When the TV is in standby mode, you can configure the settings of the power indicator.</p> <ul style="list-style-type: none"> • ON: The LED is on. • OFF: The LED is off.
	<p>TV Reset</p> <p>Returns all settings on the TV to their factory defaults.</p>

Hotel Option menu Item		Description
LYNK Cloud	Enrollment	Lets you enroll the TV with LYNK Cloud solution.
	Enrollment Status	Check the status of the TV enrollment in the LYNK Cloud service.
*Virtual Standby	Virtual Standby Mode	When the AC power cord is plugged in and the power is off, this option maintains the TV's important features even after the screen is off. <ul style="list-style-type: none"> Electricity consumption may vary depending on the environment.
	Reboot Time	After the TV power is off (in Virtual Standby Mode) if there is no input from the user within the set Reboot Time , the TV will reboot and enter Virtual Standby Mode again.
Room Number		You can set the room number of the TV's location.

- *: This function is available when **Enrollment Status** in LYNK Cloud is set to ON.
- Refer to the manual of each solution for details about functions and settings of the solutions such as LYNK Cloud.

USB Cloning

Hotel Option menu > Cloning

The USB cloning function lets you download user-configured settings (**Picture, Sound, Broadcasting, and Hotel Option menu**) from one TV to a USB device, and then upload these settings from the USB device to other TV sets. This lets you create a standard file of settings and distribute that standard file to all the TVs in your facility.

- After cloning, certain features are applied when the TV is turned on again.

Cloning TV to USB: Copies stored menu settings from a TV to a USB device

Hotel Option menu > Cloning > Clone TV to USB

1. Insert a USB device into the USB port on the rear of the TV.
2. Go to the **Hotel Option** menu.
3. Press the up or down directional button to select **Clone TV to USB**, and press the **Select** button on the remote control.
4. The cloning message is displayed.
 - The clone folder will be labelled T-NKLBDEUC.
 - The cloned values include the values on the guest side menu (**Picture, Sound, Broadcasting** and so on) and the **Hotel Option** menu.

Cloning USB to TV: Copies menu settings and channel data in a USB device to a TV

Shortcut: Turn the TV off, insert the USB device, turn the TV on, and then press the **Select** button on the remote control for 5 seconds.

To clone data to the TV using the **Hotel Option** menu, follow these steps:

1. Turn the TV off.
 2. Insert the USB device into the USB port on the rear of the TV.
 3. Turn the TV on.
 4. Go to the **Hotel Option** menu.
 5. Press the up or down directional button to select **Clone USB to TV**, and press the **Select** button on the remote control.
 6. The message **Clone settings from USB to TV** is displayed. Press the **Select** button on the remote control.
 - If there is no file to copy on the USB device or the message that there is no file appears, check the folder on your USB device.
 - The folder name should be T-NKLBDEUC.
 - Tables that list the settings that are cloned in the **Hotel Option** menu begin on the next page.
-  Turn the TV off, insert the USB device, turn the TV on, and press the **Select** button on the remote control for 5 seconds, then this menu is displayed.

Pre-condition for cloning (check point)

- Cloning should be done between same model (same SW version).
- Before cloning, all displays should be updated at the latest version (same SW version).

Settings Cloned in the Hotel Option menu

- The menu items may not be supported depending on the models.

Menu Item		Sub Item	Cloned or not
Hospitality Mode		Standalone / Interactive (Default : Standalone)	Yes
SI Vendor		Interactive: Samsung / ZM / Locatel / VDA / VDA-S / Acentic / Sustinere / Quadriga / ETV / Ibahn / Magilink / Otrum / Siemens / Amino / MDC / Enseio Standalone: Off / Movielink / Swisscom / SSCP	Yes
SI Config	MDC ID Settings	00 ~ 99	Yes
	TV Version	1.0 / 2.0	Yes
Power On	Power On Channel	User Defined / Last Saved	Yes
	Power On Channel Num	***	Yes
	Power On Channel Type	ATV / DTV / CATV / CDTV / SDTV / IPTV	Yes
	Power On Volume	User Defined / Last Saved	Yes
	Power On Volume Num	0~100	Yes
	Min Volume	0~100	Yes
	Max Volume	0~100	Yes
	Power On Source	TV / HDMI 1 / MDMI 2 / HDMI 3 / Last Saved	Yes
	Power On Option	Power On / Standby / Last Option	Yes
Channel	Channel Setup	—	Yes
	Channel Editor	—	Yes
	Mixed Channel Map	On / Off	Yes
	Dynamic SI	On / Off	Yes
	Channel Rescan Message	On / Off	Yes
	MyChannel	On / Off	Yes
	Subtitle Auto On	On / Off	Yes
	TTX Widescreen Mode	On / Off	Yes
Menu OSD	Picture Menu Lock	On / Off	Yes
	Menu Display	On / Off	Yes
	Channel Menu Display	On / Off	Yes
	Panel Button Lock	Unlock / Lock / OnlyPower	Yes
Clock	Local Time	Standalone Mode: Manual / Time Channel / TTX Interactive Mode: Manual / Time Channel / TTX / Auto	Yes
	Time Channel Type	DTV / CDTV / SDTV	Yes
	Time Channel Num	***	Yes
External Source	USB Pop-up Screen	Automatic / Disable	Yes
Power and Energy Saving	Brightness Reduction	On / Off	Yes
	Power Saving Mode Timer	0~99	Yes

Menu Item		Sub Item	Cloned or not	
Cloning	Clone TV to USB		—	No
	Clone USB to TV		—	No
	Setting Auto initialize		On / Off	Yes
Smart Service	Network Setup		—	No
	Download by App ID		—	Yes
	Apps Editable		On / Off	Yes
	Ambient Editable		On / Off	Yes
	Terms & Policy		—	Yes
	Smart Features		—	Yes
	Quick Settings Editor		—	Yes
	Samsung Account		—	No
Universal Remote	Universal Remote Setting		—	No
	Universal Remote Type		Samsung / SI	Yes
	Universal Remote Icon DL		—	Yes
Security	FactoryLock		On / Off	Yes
	Password Popup		On / Off	Yes
	Password Input		—	No
	Password Setting		—	Yes
	Password Reset		—	No
	Security Mode		On / Off	Yes
	USB		Enable / Disable	Yes
	HDMI		Enable / Disable	Yes
TTX Security		Enable / Disable	Yes	
DRM	DRM Mode		OFF/ LYNKDRM	Yes
System	Self Diagnosis for HTV	STB SI Vendor Setting	"Si Name" Ok / Failure	No
	Self Diagnosis for TV		—	No
	System Manager		—	No
	OTN Update		On / Off	Yes
	SW Update		—	No
	Remote Management		—	No
	About This TV		—	No
	Standby LED		On / Off	Yes
TV Reset		—	No	
LYNK Cloud	Enrollment		—	No
	Enrollment Status		Yes / No	No
Virtual Standby	Virtual Standby Mode		On / Off	No
	Reboot Time		5 / 15 / 30 / 60	Yes
Room Number			—	No

Setting Auto Initialize

Hotel Option menu > Cloning > Setting Auto Initialize

When you clone settings from one TV to another, you clone both the guest side menu and hotel side menu settings: **Picture, Sound, Broadcasting, and Hotel Option** menu. This lets you set nearly all of the menu values on your hospitality TVs to the same, standard settings. If you allow guests access to the guest side menus, for example the **Picture** menu, they can change the settings in those menus so they are no longer standard. If you set the **Setting Auto Initialize** function to on, the TV automatically restores (Initializes) any guest side menu values to the cloned, standard values when the TV is turned off and then turned on again. Note that **Setting Auto Initialize** works on cloned guest side menu values only. Settings which have not been cloned are ignored.

The table below lists the settings that are restored to their cloned values when you set the **Setting Auto Initialize** function to on.

- The menu items may not be supported depending on the models.

Menu Item			
Picture	Picture Mode	Dynamic	
		Standard	
		Game	
		Movie	
		FILMMAKER MODE	
	Picture Size Settings	Picture Size	
		Auto Wide	
		4:3 Screen Size	
		Fit to Screen	
		Zoom and Position	
	Expert Settings	Brightness	
		Contrast	
		Sharpness	
		Colour	
		Tint (G/R)	
		Apply Picture Settings	
		Picture Clarity Settings	Picture Clarity
			Judder Reduction
			LED Clear Motion
			Noise Reduction
		Contrast Enhancer	
	Film Mode		
	Colour Tone		

Menu Item					
Picture	Expert Settings	White Balance	2 Point	R-Gain	
				G-Gain	
				B-Gain	
				R-Offset	
				G-Offset	
				B-Offset	
				Reset	
			20 Point Settings	20 Point	
				Interval	
				Red	
				Green	
				Blue	
				Reset	
		Gamma			
		BT.1886			
		HLG			
		ST.2084			
		Shadow Detail			
		Colour Space Settings	Colour Space		
			Colour Gamut		
			Colour		
			Red		
			Green		
Blue					
Reset					
Reset Picture					

Menu Item			
Sound	Sound Output	TV Speaker	
		Receiver (Optical)	
		Bluetooth Speaker List	
	Sound Mode	Standard	
		Adaptive Sound	
		Amplify	
	Wi-Fi Speaker Surround Setup		
	Expert Settings	Balance	
		Equaliser	
		HDMI-eARC Mode	
		Digital Output Audio Format	
		Digital Output Audio Delay	
		Dolby Atmos	
		Auto Volume	
Sound Feedback			
Simultaneous Optical Output			
Reset Sound			
Device Name			
Network	Network Status		
	Open Network Settings		
	Reset Network		
	Expert Settings	Power On with Mobile	
		IP Remote	
Wi-Fi			
Connection	Anynet+ (HDMI-CEC)		
	Input Signal Plus		
	HDMI Black Level		
	Input Device Manager	Bluetooth Device List	
		Keyboard Settings	Keyboard Language
			Keyboard type
		Mouse Settings	Primary Button
	Pointer Speed		
	Device Connection Manager	Access Notification	
		Device List	
Game Mode Settings	Game Mode		
	Game Motion Plus Settings		
	Game HDR		

Menu Item				
Broadcasting	Auto Tuning			
	Auto Tuning Settings			
	Aerial			
	Common Interface			
	Dual Sound			
	Service Provider			
	Service Provider Info & Settings			
	Expert Settings	Manual Scan		
		Fine Tune		
		Transfer Channel List		
		Delete CAM Operator Profile		
		Satellite System		
		Teletext Language Settings		
		TVkey Interface		
		Audio Options	Audio Language Settings	Audio Language
	Primary Audio Language			
Secondary Audio Language				
Audio Format				
General & Privacy	Voice Guide Settings	Voice Guide		
		Volume		
		Speed		
		Pitch		
		TV Background Volume		
	Audio Description Settings	Audio Description		
		Audio Description Volume		
	Subtitle Settings	Subtitle		
		Subtitle Mode		
		Subtitle Language		
		Primary Subtitle Language		
	Sign Language Zoom Settings	Sign Language Zoom		
		Edit Sign Language Zoom		
	Picture Off			
	Multi-output Audio			
	High Contrast			
Enlarge				
Greyscale				

Menu Item				
General	Accessibility	Colour Inversion		
		Remote Button Repeat Settings	Slow Button Repeat Repeat Interval	
	Terms & Privacy			
	System Manager	Time	Clock	Clock Mode
				Date
				Time
				Time Offset
				Time Zone
				GMT
				DST
		Sleep Timer		
	Alarm			
	Language			
	Samsung Account			
	Change PIN			
	Parental Settings	Programme Rating Lock		
		Apply Channel Lock		
		Channel Lock Settings		
		App Lock Settings		
	Power and Energy Saving	Brightness Optimisation		
Minimum Brightness				
Brightness Reduction				
Motion Lighting				
Screen Saver				
Auto Power Saving				
Auto Power Off				
Available Remote Battery				
Start Screen Options	Start with Smart Hub Home			
Support	Software Update	Update now		
	Device Care			
	Remote Management			
	About This TV			

Updating the TV's Software

DO NOT turn off the TV's power until the update is complete. The TV will turn off and on automatically after completing the software update. Video and audio settings will be reset to their defaults after a software update. To easily reset the settings after software update, we recommend you to copy the TV's settings.

- For more information about the USB cloning function, refer to page 35.

Updating through a USB device

To update the TV's software, follow these steps:

1. Insert a USB device containing the software update file into the USB port of the TV.
 2. Run **SW Update**.
 - **Hotel Option** menu > **System** > **SW Update**
 3. The TV displays a pop-up message that checks for the updated version.
 4. Move the focus to **OK**, and then press the **Select** button on the remote control.
- Please be careful to not disconnect the power or remove the USB device while upgrades are being applied. The TV will turn off and turn on automatically after completing the SW upgrade. Please check the SW version after the upgrades are complete.

09 Editing Channels

Using Channel Editor

 **Hotel Option menu > Channel > Channel Editor**

Using **Channel Editor** you can edit the channels stored in the TV's memory.

- Change the channel numbers and names, edit the channel language and channel genre and delete channels.
- If you set the **Screen Off** function to **On** for the selected channels, a screen off message is displayed, and pictures are turned off by the **Screen Off** function and only audio is output from those channels.
- **Channel Editor** also lets you view information about each channel easily, without your having to display each channel directly.

General Steps for Using the Channel Editor in Standalone Mode



- The image on your TV may differ from the image above depending on the model and geographical area.
1. Run **Channel Setup (Channel > Channel Setup)** in the **Hotel Option** menu.
 2. Enter **Channel Editor (Channel > Channel Editor)** in the **Hotel Option** menu.
 3. On a piece of paper, compile a list of channels you want to have, arranged in the order you want.
 4. Based on the list created in Step 3, rearrange the channels and edit the channel names.
 5. Press the  button to exit.

Editing the Channel Number

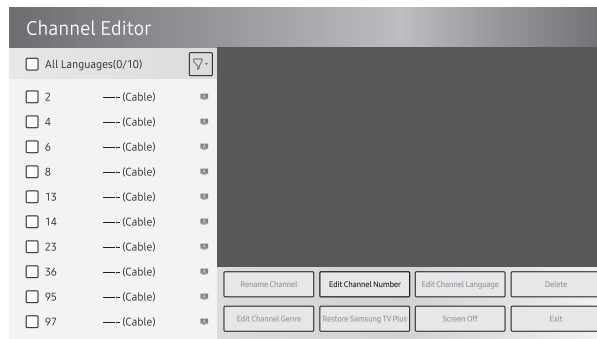

Change the channel number of a channel you select. To change a channel number, follow these steps:

1. Select a channel on the **Channel Edit** screen.
2. Use the directional buttons on the remote control, move the focus to **Edit Channel Number**, and press the **Select** button.
3. Use the up or down directional buttons on the remote control to change the channel number.
4. Move the focus to **OK** when done, and then press the **Select** button on the remote control.
 - When you change the channel number, the channel information is updated automatically.

Rename the Channel

Change the name of a channel you select. To change the name of a channel, follow these steps:

1. Select a channel on the **Channel Edit** screen.
2. Use the directional buttons on the remote control, move the focus to **Rename channel**, and then press the **Select** button.
3. Use the on-screen keyboard that appears to enter the new name for the channel. Use the directional buttons on the remote control, move the focus a letter or number, and then press the **Select** button. Repeat for each letter or number you want to enter.
4. When finished, move the focus to **Done**, and then press the **Select** button on the remote control.

Assigning the Channel Number to the external device

The external device source of the TV are displayed in the last page of the **Channel Editor** menu as shown below.

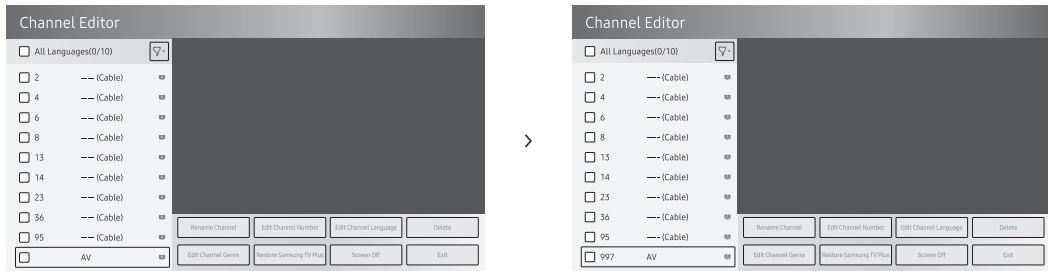

1. Select a external device source on the **Channel Edit** screen.
 2. Use the directional buttons on the remote control, move the focus to **Edit Channel Number**, and press the **Select** button.
 3. Use the up or down directional buttons on the remote control to assign the channel number.
 4. Move the focus to **OK** when done, and then press the **Select** button on the remote control.
- Once you assign a channel number to an external device, you can enter the external device without opening the TV source menu.

10 Specifications and Other Information

Specifications

Model Name	HG43BU800E	HG50BU800E
Display Resolution	3840 x 2160	3840 x 2160
Screen Size Measured Diagonally	43 inches 108 cm	50 inches 125 cm
Sound (Output)	20 W	20 W
Dimensions (W x H x D) Body With stand	965.5 x 559.9 x 25.7 mm 965.5 x 599.0 x 205.6 mm	1118.3 x 644.6 x 25.7 mm 1118.3 x 683.6 x 228.8 mm
Weight Without Stand With Stand	8.4 kg 8.7 kg	11.5 kg 11.8 kg
Model Name	HG55BU800E	HG65BU800E
Display Resolution	3840 x 2160	3840 x 2160
Screen Size Measured Diagonally	55 inches 138 cm	65 inches 163 cm
Sound (Output)	20 W	20 W
Dimensions (W x H x D) Body With stand	1232.1 x 708.8 x 25.7 mm 1232.1 x 747.8 x 228.8 mm	1450.9 x 831.9 x 25.7 mm 1450.9 x 869.6 x 281.8 mm
Weight Without Stand With Stand	15.5 kg 15.8 kg	20.9 kg 21.3 kg
Model Name	HG75BU800E	
Display Resolution	3840 x 2160	
Screen Size Measured Diagonally	75 inches 189 cm	
Sound (Output)	20 W	
Dimensions (W x H x D) Body With stand	1676.7 x 960.3 x 26.6 mm 1676.7 x 1005.5 x 340.4 mm	
Weight Without Stand With Stand	31.4 kg 32.0 kg	

Environmental Considerations

Operating Temperature	10 °C to 40 °C (50 °F to 104 °F)
Operating Humidity	10 % to 80 %, non-condensing
Storage Temperature	-20 °C to 45 °C (-4 °F to 113 °F)
Storage Humidity	5 % to 95 %, non-condensing

Notes

- This device is a Class B digital apparatus.
- The design and specifications are subject to change without prior notice.
- For information about the power supply, and more information about power consumption, refer to the label-rating attached to the product.
- You can see the label-rating attached to the back of the TV. (For some models, you can see the label-rating inside the cover terminal.)
- Typical power consumption is measured according to IEC 62087.
- Recommended hours of use per day of this product is under 8 hours. If the product is used for longer than 8 hours a day, the warranty may be void.

To access energy labelling information about this product on the European Product Registry for Energy Labelling (EPREL), go to https://eprel.ec.europa.eu/qr/*****

where ***** is the product's EPREL registration number. You can find the registration number on the rating label of your product.

Decreasing power consumption

When you shut the TV off, it enters Standby mode. In Standby mode, it continues to draw a small amount of power. To decrease power consumption, unplug the power cord when you don't intend to use the TV for a long time.

Supported Resolutions for UHD Input Signals

- Resolution: 3840 x 2160p, 4096 x 2160p

If Input Signal Plus is set to Off

Frame rate (fps)	Colour Depth / Chroma Sampling	RGB 4:4:4	YCbCr 4:4:4	YCbCr 4:2:2	YCbCr 4:2:0
50 / 60	8 bit	-	-	-	0

If Input Signal Plus is set to On

Frame rate (fps)	Colour Depth / Chroma Sampling	RGB 4:4:4	YCbCr 4:4:4	YCbCr 4:2:2	YCbCr 4:2:0
50 / 60	8 bit	0	0	0	0
	10 bit	-	-	0	0

Supported Resolutions for Connecting a Computer

When you use your TV as a computer monitor, you can also select one of the standard resolutions listed in the Resolution column. The TV will automatically adjust to the resolution you choose.

Mode	Resolution	Display format	Horizontal frequency (KHz)	Vertical frequency (Hz)	Clock frequency (MHz)	Polarity (horizontal / vertical)
IBM	720 x 400	70 Hz	31.469	70.087	28.322	-/+
MAC	640 x 480	67 Hz	35.000	66.667	30.240	-/-
	832 x 624	75 Hz	49.726	74.551	57.284	-/-
	1152 x 870	75 Hz	68.681	75.062	100.000	-/-
VESA DMT	640 x 480	60 Hz	31.469	59.940	25.175	- / -
	640 x 480	72 Hz	37.861	72.809	31.500	- / -
	640 x 480	75 Hz	37.500	75.000	31.500	- / -
	800 x 600	60 Hz	37.879	60.317	40.000	+ / +
	800 x 600	72 Hz	48.077	72.188	50.000	+ / +
	800 x 600	75 Hz	46.875	75.000	49.500	+ / +
	1024 x 768	60 Hz	48.363	60.004	65.000	- / -
	1024 x 768	70 Hz	56.476	70.069	75.000	- / -
	1024 x 768	75 Hz	60.023	75.029	78.750	+ / +
	1152 x 864	75 Hz	67.500	75.000	108.000	+ / +
	1280 x 720	60 Hz	45.000	60.000	74.250	+ / +
	1280 x 800	60 Hz	49.702	59.810	83.500	- / +
	1280 x 1024	60 Hz	63.981	60.020	108.000	+ / +
	1280 x 1024	75 Hz	79.976	75.025	135.000	+ / +
	1440 x 900	60 Hz	55.935	59.887	106.500	- / +
	1600 x 900	60 Hz	60.000	60.000	108.000	+ / +
	1680 x 1050	60 Hz	65.290	59.954	146.250	- / +
1920 x 1080	60 Hz	67.500	60.000	148.500	+ / +	
VESA CVT	2560 x 1440	60 Hz	88.787	59.951	241.500	+ / -
	2560 x 1440	120 Hz	192.996	119.998	497.750	+ / -

Mode	Resolution	Display format	Horizontal frequency (KHz)	Vertical frequency (Hz)	Clock frequency (MHz)	Polarity (horizontal / vertical)
CTA-861	1920 x 1080i	50 Hz	28.125	50.000	74.250	+ / +
	1920 x 1080i	60 Hz	33.750	60.000	74.250	+ / +
	*1920 x 1080	100 Hz	112.500	100.000	297.000	+ / +
	*1920 x 1080	120 Hz	135.000	120.003	297.000	+ / +
	3840 x 2160	30 Hz	67.500	30.000	297.000	- / -
	*3840 x 2160	60 Hz	135.000	60.000	594.000	- / -
	*3840 x 2160	100 Hz	225.000	100.000	1188.000	+ / +
	*3840 x 2160	120 Hz	270.000	120.000	1188.000	+ / +
	4096 x 2160	24 Hz	54.000	24.000	297.000	+ / +
	4096 x 2160	30 Hz	67.500	30.000	297.000	+ / +
	*4096 x 2160	50 Hz	112.500	50.000	594.000	+ / +
	*4096 x 2160	60 Hz	135.000	60.000	594.000	+ / +
	*4096 x 2160	100 Hz	225.000	100.000	1188.000	+ / +
	*4096 x 2160	120 Hz	270.000	120.000	1188.000	+ / +
	*7680 x 4320	24 Hz	108.000	24.000	1188.000	+ / +
	*7680 x 4320	30 Hz	132.000	30.000	1188.000	+ / +
	*7680 x 4320	50 Hz	220.000	50.000	2376.000	+ / +
*7680 x 4320	60 Hz	264.000	60.000	2376.000	+ / +	

- *: The resolution may not be supported depending on the model.
- The interlaced mode is not supported.
- The set might operate abnormally if you select a non-standard video format.
- Separate and Composite modes are supported. SOG (Sync On Green) is not supported.
- Set **Apps Editable** to **ON** to change the input source (**Edit Name/Icon**) manually.
 - Hotel Option menu > Smart Service > Apps Editable

Supported Resolutions for Video Signals

Check the resolutions supported for video signals.

Mode	Resolution	Display format	Horizontal frequency (KHz)	Vertical frequency (Hz)	Clock frequency (MHz)	Polarity (horizontal / vertical)
CTA-861	720 (1440) x 576i	50 Hz	15.625	50.000	27.000	- / -
	720 (1440) x 480i	60 Hz	15.734	59.940	27.000	- / -
	720 x 576	50 Hz	31.250	50.000	27.000	- / -
	720 x 480	60 Hz	31.469	59.940	27.000	- / -
	1280 x 720	50 Hz	37.500	50.000	74.250	+ / +
	1280 x 720	60 Hz	45.000	60.000	74.250	+ / +
	1920 x 1080i	50 Hz	28.125	50.000	74.250	+ / +
	1920 x 1080i	60 Hz	33.750	60.000	74.250	+ / +
	1920 x 1080	24 Hz	27.000	24.000	74.250	+ / +
	1920 x 1080	25 Hz	28.125	25.000	74.250	+ / +
	1920 x 1080	30 Hz	33.750	30.000	74.250	+ / +
	1920 x 1080	50 Hz	56.250	50.000	148.500	+ / +
	*1920 x 1080	100 Hz	112.500	100.000	297.000	+ / +
	*1920 x 1080	120 Hz	135.000	120.003	297.000	+ / +
	1920 x 1080	60 Hz	67.500	60.000	148.500	+ / +
	3840 x 2160	24 Hz	54.000	24.000	297.000	+ / +
	3840 x 2160	25 Hz	56.250	25.000	297.000	+ / +
	3840 x 2160	30 Hz	67.500	30.000	297.000	+ / +
	*3840 x 2160	50 Hz	112.500	50.000	594.000	+ / +
	*3840 x 2160	60 Hz	135.000	60.000	594.000	+ / +
	*3840 x 2160	100 Hz	225.000	100.000	1188.000	+ / +
	*3840 x 2160	120 Hz	270.000	120.000	1188.000	+ / +
	4096 x 2160	24 Hz	54.000	24.000	297.000	+ / +
	4096 x 2160	25 Hz	56.250	25.000	297.000	+ / +
	4096 x 2160	30 Hz	67.500	30.000	297.000	+ / +
	*4096 x 2160	50 Hz	112.500	50.000	594.000	+ / +
	*4096 x 2160	60 Hz	135.000	60.000	594.000	+ / +
	*4096 x 2160	100 Hz	225.000	100.000	1188.000	+ / +
	*4096 x 2160	120 Hz	270.000	120.000	1188.000	+ / +
	*7680 x 4320	24 Hz	108.000	24.000	1188.000	+ / +
	*7680 x 4320	30 Hz	132.000	30.000	1188.000	+ / +
	*7680 x 4320	50 Hz	220.000	50.000	2376.000	+ / +
*7680 x 4320	60 Hz	264.000	60.000	2376.000	+ / +	
VESA CVT	2560 x 1440	60 Hz	88.787	59.951	241.500	+ / -
	2560 x 1440	120 Hz	192.996	119.998	497.750	+ / -

- *: The resolution may not be supported depending on the model.
- Set **Apps Editable** to **ON** to change the input source (**Edit Name/Icon**) manually.
 - **Hotel Option menu > Smart Service > Apps Editable**

Read Before Using the Internet Function

Read this information before using the Internet function.

- File download is not supported.
- The **Internet** function may not be able to access certain websites, including websites operated by certain companies.
- The TV does not support playback of flash videos.
- E-commerce for online purchases is not supported.
- ActiveX is not supported.
- Only a limited number of fonts are supported. Certain symbols and characters may not be displayed properly.
- The response to remote commands and the resulting on-screen display may be delayed while a web page is loading.
- Loading a web page may be delayed or suspended completely depending on the status of the participating systems.
- Copy and paste operations are not supported.
- When composing an email or a simple message, certain functions such as the font size and colour selection may not be available.
- There is a limit to the number of bookmarks and the size of the log file that can be saved.
- The number of windows that can be opened concurrently is limited.
- Web browsing speed will differ with the network environment.
- Embedded videos in a web page cannot be played at the same time while the PIP (picture-in-picture) function is operating.
 - This function may not be supported depending on the model or geographical area.
- Browsing history is saved from latest to oldest, with the oldest entries being overwritten first.
- Depending on the types of video/audio codecs supported, you may not be able to play certain HTML5 video and audio files.
- Video sources from PC-optimised streaming service providers may not play properly on our proprietary **Internet** browser.

Dimensions

- The displayed image may differ from your TV, depending on the model.
- Detailed dimensions can be checked at Displaysolutions.samsung.com.

Front view / Side view

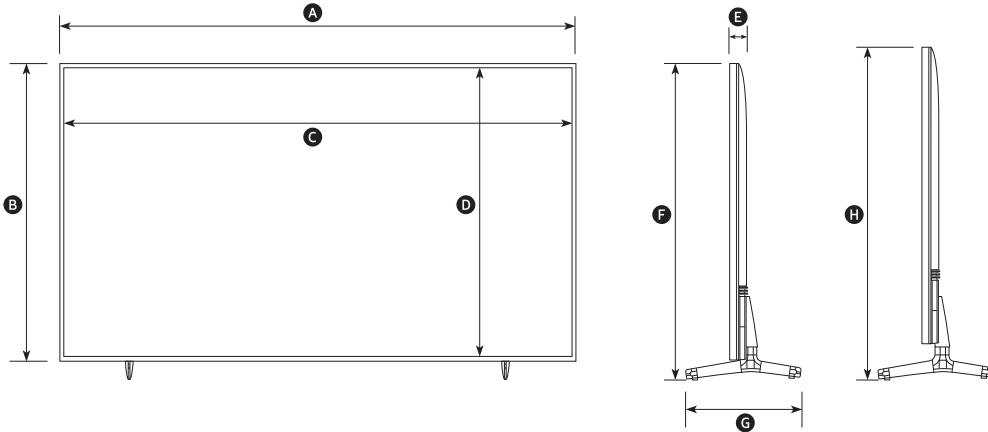

Unit: inches	A (mm)	B (mm)	C (mm)	D (mm)	E (mm)	F (mm)	G (mm)	H (mm)
43	965.5	559.9	953.0	538.0	25.7	599.0	205.6	624.0
50	1118.3	644.6	1105.8	623.4	25.7	683.6	228.8	708.6
55	1232.1	708.8	1218.2	686.7	25.7	747.8	228.8	772.8
65	1450.9	831.9	1438.5	810.5	25.7	869.6	281.8	894.6
75	1676.7	960.3	1662.2	936.8	26.6	1005.5	340.4	1030.5

Rearview

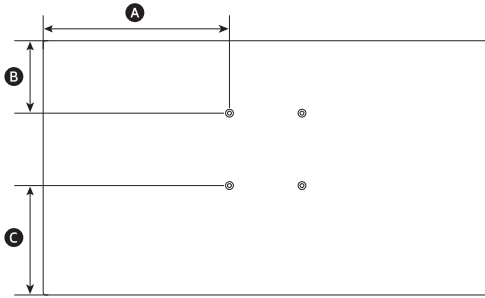

Unit: inches	A (mm)	B (mm)	C (mm)
43	382.8	192.2	167.7
50	459.2	207.4	237.2
55	516.1	239.3	269.5
65	525.5	264.0	267.9
75	638.4	259.6	300.7

Base Stand detail

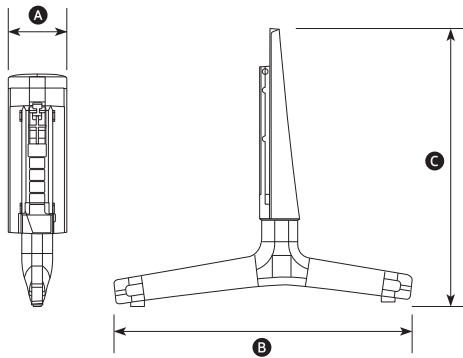

Unit: inches	A (mm)	B (mm)	C (mm)
43	37.8	205.6	211.6
50-55	39.9	228.8	217.0
65	39.8	281.8	217.9
75	41.9	340.4	235.2

Licences



Dolby, Dolby Atmos, Dolby Audio and the double-D symbol are registered trademarks of Dolby Laboratories Licensing Corporation. Manufactured under license from Dolby Laboratories. Confidential unpublished works. Copyright © 2012-2021 Dolby Laboratories. All rights reserved.

POWERED BY

QUICKSET[®]



THIS PRODUCT IS SOLD WITH A LIMITED LICENCE AND IS AUTHORISED TO BE USED ONLY IN CONNECTION WITH HEVC CONTENT THAT MEETS EACH OF THE THREE FOLLOWING QUALIFICATIONS: (1) HEVC CONTENT ONLY FOR PERSONAL USE; (2) HEVC CONTENT THAT IS NOT OFFERED FOR SALE; AND (3) HEVC CONTENT THAT IS CREATED BY THE OWNER OF THE PRODUCT.



THIS PRODUCT MAY NOT BE USED IN CONNECTION WITH HEVC ENCODED CONTENT CREATED BY A THIRD PARTY, WHICH THE USER HAS ORDERED OR PURCHASED FROM A THIRD PARTY, UNLESS THE USER IS SEPARATELY GRANTED RIGHTS TO USE THE PRODUCT WITH SUCH CONTENT BY A LICENSED SELLER OF THE CONTENT.

YOUR USE OF THIS PRODUCT IN CONNECTION WITH HEVC ENCODED CONTENT IS DEEMED ACCEPTANCE OF THE LIMITED AUTHORITY TO USE AS NOTED ABOVE.



The terms HDMI and HDMI High-Definition Multimedia Interface, and the HDMI Logo are trademarks or registered trademarks of HDMI Licensing Administrator, Inc. in the United States and other countries.

Open Source License Notice

Open Source used in this product can be found on the following webpage. (<https://opensource.samsung.com>)

SAMSUNG

Contact SAMSUNG WORLD WIDE

If you have any questions or comments relating to Samsung products, please contact the Samsung service centre.

Country	Samsung Service Centre ☎	Web Site
AUSTRIA	0800 72 67 864 (0800-SAMSUNG)	www.samsung.com/at/support
BELGIUM	02-201-24-18	www.samsung.com/be/support (Dutch) www.samsung.com/be_fr/support (French)
BOSNIA	055 233 999	www.samsung.com/ba/support
ALBANIA	045 620 202	www.samsung.com/al/support
BULGARIA	0800 111 31 - Безплатен за всички оператори *3000 - Цена на един градски разговор или според тарифата на мобилният оператор 09:00 до 18:00 - Понеделник до Петък	www.samsung.com/bg/support
CROATIA	072 726 786	www.samsung.com/hr/support
CZECH	800 - SAMSUNG (800-726786) Samsung Electronics Czech and Slovak, s.r.o. V Parku 2323/14, 148 00 - Praha 4	www.samsung.com/cz/support
DENMARK	707 019 70	www.samsung.com/dk/support
FINLAND	030-6227 515	www.samsung.com/fi/support
FRANCE	01 48 63 00 00	www.samsung.com/fr/support
GERMANY	06196 77 555 77	www.samsung.com/de/support
CYPRUS	8009 4000 only from landline, toll free	www.samsung.com/gr/support
GREECE	80111-SAMSUNG (80111 726 7864) only from land line (+30) 210 6897691 from mobile and land line	
HUNGARY	0680SAMSUNG (0680-726-7864)	www.samsung.com/hu/support
ITALIA	800-SAMSUNG (800.7267864)	www.samsung.com/it/support
LUXEMBURG	261 03 710	www.samsung.com/be_fr/support
NORTH MACEDONIA	023 207 777	www.samsung.com/mk/support
MONTENEGRO	020 405 888	www.samsung.com/support
SLOVENIA	080 697 267 (brezplačna številka)	www.samsung.com/si/support
NETHERLANDS	088 90 90 100	www.samsung.com/nl/support
NORWAY	21629099	www.samsung.com/no/support
POLAND	801-172-678* lub +48 22 607-93-33* * (opłata według taryfy operatora)	www.samsung.com/pl/support
PORTUGAL	210 608 098	www.samsung.com/pt/support
ROMANIA	0800872678 - Apel gratuit *8000 - Apel tarifat în rețea Program Call Center Luni - Vineri: 9 AM - 6 PM	www.samsung.com/ro/support
SERBIA	011 321 6899	www.samsung.com/rs/support
KOSOVO	038 40 30 90	www.samsung.com/support
SLOVAKIA	0800 - SAMSUNG (0800-726 786)	www.samsung.com/sk/support
SPAIN	91175 00 15	www.samsung.com/es/support
SWEDEN	0771-400 300	www.samsung.com/se/support
SWITZERLAND	0800 726 786	www.samsung.com/ch/support (German) www.samsung.com/ch_fr/support (French)
UK	0333 000 0333	www.samsung.com/uk/support
IRELAND (EIRE)	0818 717100	www.samsung.com/ie/support
LITHUANIA	8-800-77777	www.samsung.com/lt/support
LATVIA	8000-7267	www.samsung.com/lv/support
ESTONIA	800-7267	www.samsung.com/ee/support
TÜRKİYE	444 77 11	www.samsung.com/tr/support